

*Leader in rubber since more than 30 years*



Merlino plant

dega design group



02.2008



**FLEXIBLE POWER AND CONTROL CABLE**

*for mobile application and heavy duty service*

Sales Head Office

Prysmian Cavi e Sistemi Energia Italia srl  
Viale Sarca 222, 20126 Milano, Italy, tel. +39 02 6449 1, fax +39 02 6440 2440

[www.prysmian.it](http://www.prysmian.it)

---

## Introduction

**PALAZZO** has a history of producing special purpose cables for special applications. For cables that will be continuously flexed, reeled, tensioned, and installed in demanding and harsh environment, **PALAZZO** has developed a flexible cable that excels in its use.

**PALAZZO PANZERFLEX** is the cable and its reliability is very well known throughout the world.

There is virtually no limit to the types of flexible cables that **PALAZZO** can produce. Specially tailored cables can be designed and manufactured according to a wide range of specific application.

This specialization means the **PALAZZO** cables are more able to meet each customer's particular requirements and demands than general purpose flexible cables, helping customers to improve performance while reducing down time.

**PALAZZO** understands the needs of customers to have local approvals and actively works to carry the Marking and Approvals that are needed. For the latest technology of cables for indoor applications, **PALAZZO** can produce the Mobile Cable described in halogen free version, with no toxic gases and opaque fumes emission according to the most severe international standards.

The product information given in this catalogue represent only a first step in introducing our cable. It is a Testament of our ongoing efforts to provide our customers with not only the best products, but also the right information.

Do not hesitate to contact our Sales Office for any additional information regarding any flexible cable application you may have.

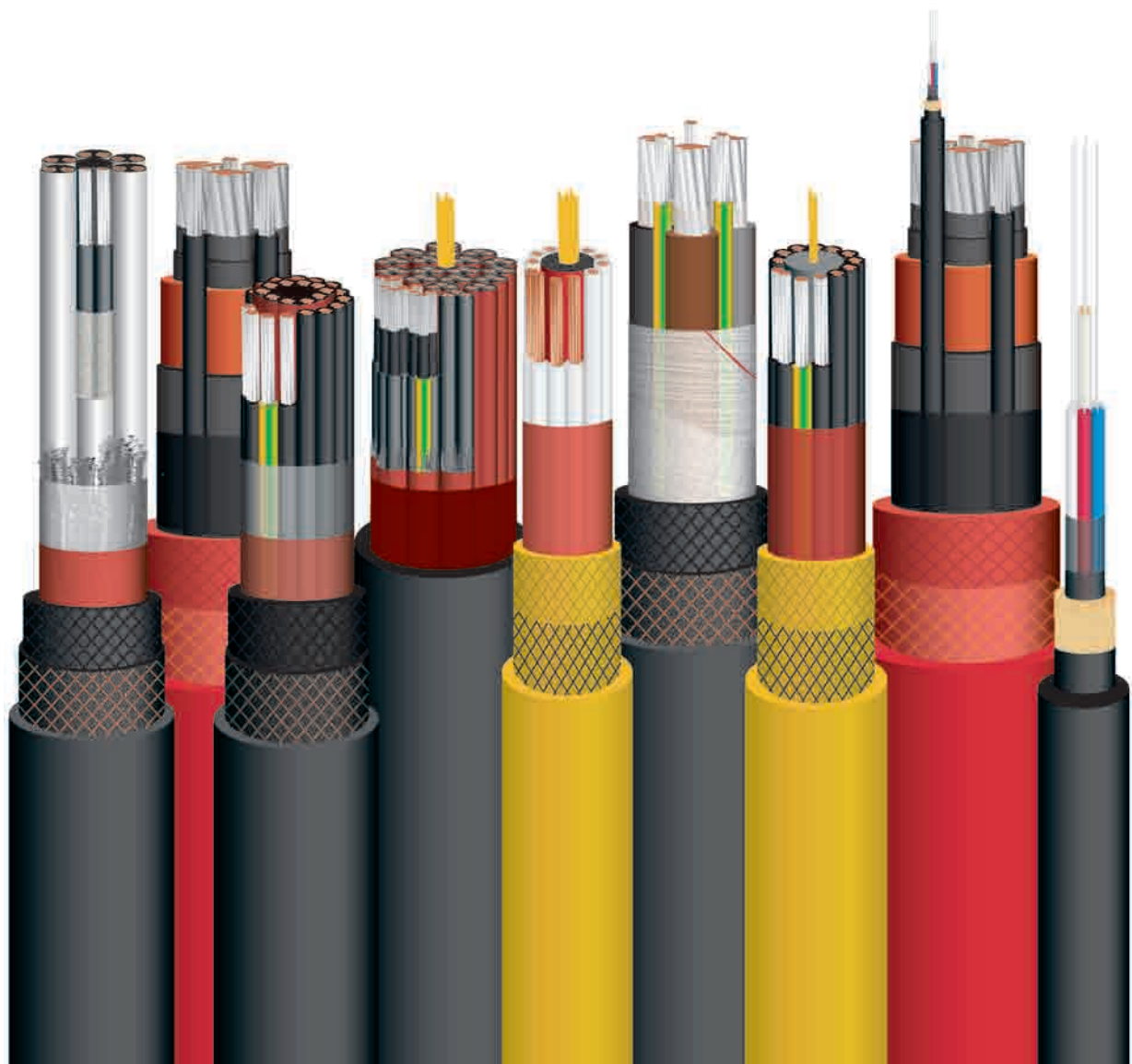

## Index

Benefits, standards	pag. 04
References and quality certificates	pag. 05
Cable use guide	pag. 07

### LOW VOLTAGE REELING AND FESTOONING



PANZERFLEX-L	0.6/1 kV (N)SHTÖU-J / -O	pag. 10
PANZERFLEX-L	0.6/1 kV (N)SHTÖU-JZ/ -OZ	pag. 12
PANZERFLEX-SIGNAL	0.6/1 kV (N)SHTÖU-JZ/ -OZ	pag. 14
FLEXIFLAT	450/750 V (N)GFLGÖU	pag. 16
FESTOONFIBERFLEX		pag. 18

### VERTICAL APPLICATION AND HIGH TENSILE LOAD



PANZERFLEX-VS	0.6/1 kV NSHTÖU-J/ -O; NSHTÖU -JZ / OZ	pag. 22
PANZERLITE	0.6/1 kV	pag. 24

### BASKET APPLICATION



BASKETHEAVYFLEX	300/500 V GRDGÖU	pag. 28
-----------------	------------------	---------

### MEDIUM VOLTAGE REELING AND FESTOONING



PANZERFLEX-ELX	3,6 ÷ 12/20 kV (N)TSCGEWÖU	pag. 32
PANZERFLEX-ELX+OF	3,6 ÷ 12/20 kV (N)TSCGEWÖU	pag. 34
PANZERFLAT-ELX	3,6 ÷ 12/20 kV (N)3GFLCGEWÖU	pag. 36

### TECHNICAL INFORMATION

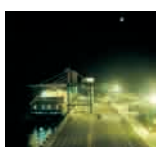

Bending Radii	pag. 40
Handling and installation	pag. 41
Electrical	pag. 46
Drum dimensions and weight	pag. 53

## Benefits

According with **PALAZZO** philosophy and technology, the **PANZERFLEX** cables can offer several important benefits:

- . Highly duration under constant severe movable conditions;
- . Tinned copper conductors provide easy solder ability and corrosion resistance;
- . Easy stripping;
- . Outstanding physical and electrical properties;
- . Ozone resistant;
- . Extremely resistant to inducted twisting and corkscrewing;
- . Increased vertical suspension performance and conductor life;
- . Excellent resistance to heat, oil, gasoline, kerosene, and alkalis in both severe indoor and outdoor applications;
- . Short manufacturing lengths availability.

## Standards

Our cables follow - as main line - the design regulation given by the DIN VDE standards.

DIN = German Standard Institute.

VDE = Association of German Electrical Engineers.

Moreover, as international standards, we take into account also the UL standards

UL = Underwriters Laboratories Inc.

**VDE**



You will find the specific reference to the standards in each cable description.

## References



The Palazzo **PANZERFLEX** cables are installed on some of the fastest and tallest cranes in the today's market.

We supply some of the worldwide well known cranes producers such as SPMP, ZPMC, Hyundai, Konecranes, Krupp, Impsa, Liebherr, Mitsubishi, Samsung, Fantuzzi Reggiane.

Also the major reels constructors like Cavotec/Specimas, Delachaux-Conductix, Stemmann and Wampfler are our regular customers.

Our Panzerflex cables are also installed on the major harbours (Thames Port, Los Angeles, Hong Kong, Shanghai, Hamburg, Sydney, TCT Taranto, VTE Genoa, MED CENTER Gioia Tauro, etc.) and in heavy industrial facilities such as steel mills (ILVA-Riva Acciai, Techint, Arcelor), paper mills, platforms, shipyards, etc.

## Quality certificates





## Cable use guide

		CABLE WINDING REELS									
		festoons	cable laid on ground or in conduit		vertical cable	cable tender systems	guide pulley systems	pendant push buttons	cable carrier chains	basket	
LOW VOLTAGE CABLES	PANZERFLEX-L 0.6/1 kV (N)SHTÖU	■	□	■	■	□	□	□	■	□	
	PANZERFLEX-VS 0.6/1 kV	□	■	■	■	■	■	■	□	□	
	PANZERLITE 0.6/1 kV	□	■	■	■	■	■	■	□	□	
MEDIUM VOLTAGE CABLES	PANZERFLEX-ELX up to 20 kV (N)TSCGEWÖU	■	■	■	■	□	□	□	■	□	
	PANZERFLEX-ELX+FO up to 20 kV (N)TSCGEWÖU	■	■	■	■	□	□	□	■	□	
	PANZERFLAT-ELX up to 10 kV	■	■	□	□	□	□	□	□	□	
OTHERS CABLES	FLEXIFLAT 450/750 kV (N)GFLGÖU	■	□	□	□	□	□	□	■	□	
	BASKETHEAVYFLEX 300/500 kV	□	□	□	□	□	□	□	□	■	
	FESTOONFIBERFLEX	■	■	□	□	□	□	□	□	□	

The above table is designed in order to give an easy reference in cable selection for the main mobile equipment application. Please keep in mind that when using this guide all the concurrent factors are to be considered: bending radii, speed, ambient temperature and tension. Even if only one of these parameters stands outside the given data of this catalogue, please contact our sales department for gaining further information.

**NO APPLICATION    MAIN APPLICATION    SUITABLE**







Courtesy of: REGGIANE CRANES and PLANTS - FANTUZZI GROUP - Italy



## LOW VOLTAGE REELING AND FESTOONING

### Cable type

#### PANZERFLEX-L 0.6/1 kV

(N)SHTÖU-J / -0 rubber cables suitable for reeling & festoon system

### Main application

Flexible power cables for use on connecting movable parts of machine tools and any material handling equipment (i.e. Stacker/reclaimer, ship to shore crane, container crane festoon, grabtype ship unloading, gantry festoons, timber crane festoons, etc.).

Suitable for any energy supply on cable reels and festoon systems associated to high mechanical stresses, frequent bending/torsional operation and fast movement with strong acceleration.

### Construction

Conductor:	Tinned copper conductor, flexible cl.5 IEC 60228 Specially designed for mobile application
Insulation:	HEPR compound better than 3GI3 New specially developed crushproof compound with improved electrical and mechanical characteristics
Cores identification:	Colours according to according to DIN VDE 0293 part 308 / HD 308 S2 Standard colours: - 1 core: black - 3+3 cores: brown, black, grey + 3 green/yellow - 4 cores: green/yellow, brown, black, grey - 5 cores: green/yellow, blue, brown, black, grey
Laying-up:	Short lay length for better flexibility ≤7,5 times the laying-up cores diameter
Separation (if any):	Tape(s)
Inner sheath:	Polychloroprene rubber based compound Better than GM1b
Antitwisting protection:	Synthetic yarns Firmly bonded between inner and outer sheath
Outer sheath:	Black polychloroprene rubber compound UV resistant oil and chemical resistant better than 5GM2
Marking:	PALAZZO - PANZERFLEX-L 0,6/1 kV <i>nc</i> x cross section

### Parameters

Electrical	Rated voltage	U <sub>0</sub> /U= 0,6/1 kV
	Maximum permissible operating voltage in AC systems	U <sub>m</sub> = 1,2 kV
	AC test voltage over 5 minutes	3,5 kV
	Current Carrying Capacity	According to DIN VDE 0298 part 4
Thermal	Fully flexible operation	- 25 °C
	Fixed installation	- 40 °C
	Maximum permissible operating temperature of the conductor	90 °C
	Short-circuit temperature of the conductor	250 °C
Mechanical	Tensile load	Up to 20 N/mm <sup>2</sup>
	Minimum bending radii	According to DIN VDE 0298 part 3
	Reeling operation	No restriction. Consult the manufacturer if speed exceeds 180 m/min
	Festoon systems	Up to 240 m/min
Chemical	Resistance to oil	According to VDE / IEC standard
	Weather resistance	Unrestricted use outdoor and indoor, UV resistant, moisture resistant.

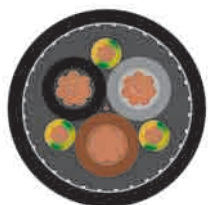

If the environment reaches - 40 °C, Palazzo can provide a special version of this cable (differentiated from the standard one by the "-K" add to the code name), which is constructed with a special rubber compound that can face this condition.

For temperature down to - 40 °C we suggest to use the Panzerflex-K. To allow this cable operating at - 40°C we use an outer-sheath compound that is less resistant to abrasion and tear so please contact our sales department for more information regarding application.

**Table 1: PANZERFLEX-L 0.6/1 kV (N)SHTÖU-J /-O power cables**

N. of cores and nominal section (n-mm <sup>2</sup> )	Main conductor		Splitted protec. earth cond. nom. diam. mm	Overall diameter		Net weight approx. kg/km	Maximum permissible tensile force N	Laid straight A	Current carrying capacity at 30 °C *				Short circuit current 80 ° to 200 °C kA-1 sec.
	D.C. resist. at 20 °C Ohm/km	nom. diam. mm		min. mm	max. mm				Suspended in free air A	Spiral or 1 layer A	2 layer A	3 layer A	
1x16	1,24	5,4		10,6	12,7	265	240	141	148	-	-	-	2,0
1x25	0,795	6,6		12,2	14,3	370	375	187	196	-	-	-	3,2
1x35	0,565	8,0		13,9	15,9	505	525	231	243	-	-	-	4,5
1x50	0,393	9,3		15,6	17,7	650	750	288	302	-	-	-	6,4
1x70	0,277	11,2		17,6	19,7	875	1050	357	375	-	-	-	9,0
1x95	0,210	13,0		20,0	22,1	1120	1425	430	452	-	-	-	12,2
1x120	0,164	15,0		22,2	24,3	1440	1500	503	528	-	-	-	15,4
1x150	0,132	16,9		24,9	27,0	1730	2250	577	606	-	-	-	19,2
1x185	0,108	18,3		26,7	28,8	2070	2775	658	691	-	-	-	23,7
1x240	0,0817	20,5		29,0	32,2	2660	3600	771	810	-	-	-	30,7
3x4	5,09	2,4		14,9	17,0	395	240	41	43	33	25	20	0,51
3x6	3,39	3,1		17,2	19,3	525	360	53	56	42	32	26	0,77
3x10	1,95	4,2		20,3	22,4	765	600	74	78	59	45	36	1,3
3x16	1,24	5,4		23,6	25,7	1080	960	99	104	79	60	49	2,0
3x25	0,795	6,6		27,0	29,1	1470	1500	131	138	105	80	64	3,2
3x35	0,565	8,0		30,4	33,6	2030	2100	162	170	130	99	79	4,5
3x50	0,393	9,3		35,4	38,6	2680	3000	202	212	162	123	99	6,4
3x70	0,277	11,2		39,6	42,8	3530	4200	250	263	200	153	123	9,0
3x95	0,210	13,0		43,8	47,0	4400	5700	301	316	241	184	147	12,2
3x120	0,164	15,0		49,0	53,5	5730	7200	352	370	282	215	172	15,4
3x150	0,132	16,9		55,5	60,0	7040	9000	404	424	323	246	198	19,2
3x185	0,108	18,3		59,5	64,0	8320	11100	461	484	369	281	226	23,7
3x240	0,0817	20,5		67,5	72,0	10850	14400	540	567	432	329	265	30,7
4x4	5,09	2,4		16,0	18,1	460	320	41	43	33	25	20	0,51
4x6	3,39	3,1		18,4	20,5	615	480	53	56	42	32	26	0,77
4x10	1,95	4,2		21,9	24,0	920	800	74	78	59	45	36	1,3
4x16	1,24	5,4		25,5	27,6	1310	1280	99	104	79	60	49	2,0
4x25	0,795	6,6		29,6	32,8	1860	2000	131	138	105	80	64	3,2
4x35	0,565	8,0		33,2	36,4	2490	2800	162	170	130	99	79	4,5
4x50	0,393	9,3		38,4	41,6	3300	4000	202	212	162	123	99	6,4
4x70	0,277	11,2		43,6	46,8	4420	5600	250	263	200	153	123	9,0
4x95	0,210	13,0		48,5	53,0	5610	7600	301	316	241	184	147	12,2
4x120	0,164	15,0		55,5	60,0	7360	9600	352	370	282	215	172	15,4
4x150	0,132	16,9		61,0	65,5	8770	12000	404	424	323	246	198	19,2
4x185	0,108	18,3		67,5	72,0	10730	14800	461	484	369	281	226	23,7
4x240	0,0817	20,5		74,0	78,5	13560	19200	540	567	432	329	265	30,7
5x4	5,09	2,4		18,0	20,1	575	400	41	43	33	25	20	0,51
5x6	3,39	3,1		19,8	21,9	725	600	53	56	42	32	26	0,77
5x10	1,95	4,2		24,5	26,6	1140	1000	74	78	59	45	36	1,3
5x16	1,24	5,4		27,6	29,7	1550	1600	99	104	79	60	49	2,0
5x25	0,795	6,6		32,2	35,4	2170	2500	131	138	105	80	64	3,2
5x35	0,565	8,0		37,0	40,2	3080	3500	162	170	130	99	79	4,5
5x50	0,393	9,3		42,2	45,4	4010	5000	202	212	162	123	99	6,4
5x70	0,277	11,2		48,0	52,5	5480	7000	250	263	200	153	123	9,0
5x95	0,210	13,0		54,5	59,0	7010	9500	301	316	241	184	147	12,2
3x50+3x25/3	0,393	9,3	4,0	34,2	37,4	2730	3000	202	212	162	123	99	6,4
3x70+3x35/3	0,277	11,2	4,9	39,6	42,8	3740	4200	250	263	200	153	123	9,0
3x95+3x50/3	0,210	13,0	5,4	43,8	47,0	4690	5700	301	316	241	184	147	12,2
3x120+3x70/3	0,164	15,0	6,6	49,5	54,0	6220	7200	352	370	282	215	172	15,4
3x150+3x70/3	0,132	16,9	6,6	55,5	60,0	7480	9000	404	424	323	246	198	19,2
3x185+3x95/3	0,108	18,3	8,0	59,5	64,0	9020	11100	461	484	369	281	226	23,7
3x240+3x120/3	0,0817	20,5	9,3	67,5	72,0	11760	14400	540	567	432	329	265	30,7
4x10+4x2.5	1,95	4,2		23,2	25,3	1060	80	74	78	59	45	36	1,3
4x16+4x2.5	1,24	5,4		25,5	27,6	1360	1280	99	104	79	60	4	2,0
4x25+4x2.5	0,795	6,6		29,6	32,8	1910	2000	131	138	105	80	64	3,2
4x35+4x2.5	0,565	8,0		32,8	36,0	2530	2800	162	170	130	99	79	4,5
4x50+4x4	0,393	9,3		38,0	41,2	3370	4000	202	212	162	123	99	6,4

\*Tabulated values are valid up to three loaded conductors with or without earth

### Cable type

#### PANZERFLEX-L 0.6/1 kV

(N)SHTÖU-JZ / -OZ rubber cables suitable for reeling & festoon system

### Main application

Flexible control cables for use on connecting movable parts of machine tools and any material handling equipment (i.e. Stacker/reclaimer, ship to shore crane, container crane, festoon, grabtype ship unloading, gantry festoons, timber crane festoons, etc.). Suitable for signalling supply on cable reels and festoon systems associated to high mechanical stresses, frequent bending/torsional operation and fast movement with strong acceleration.

### Construction

Conductor:	Tinned copper conductor, flexible cl.5 IEC 60228 Specially designed for mobile application
Insulation:	HEPR compound better than 3GI3 New specially developed crushproof compound with improved electrical and mechanical characteristics
Cores identification:	Black with printed numbers with or without 1 green/yellow Standard: with green/yellow core in the outer layer
Laying-up:	Short lay length for better flexibility ≤7,5 times the laying-up cores diameter in maximum 3 layer
Separation (if any):	Tape(s)
Inner sheath:	Polychloroprene rubber based compound Better than GM1b
Antitwisting protection:	Synthetic yarns Firmly bonded between inner and outer sheath
Outer sheath:	Black polychloroprene rubber compound UV resistant, oil and chemical resistant better than 5GM2
Marking:	PALAZZO - PANZERFLEX-L 0,6/1 kV <i>nc x cross section</i>

### Parameters

Electrical	Rated voltage	U <sub>0</sub> /U= 0,6/1 kV
	Maximum permissible operating voltage in AC systems	U <sub>m</sub> = 1,2 kV
	AC test voltage over 5 minutes	3,5 kV
	Current Carrying Capacity	According to DIN VDE 0298 part 4
Thermal	Fully flexible operation	- 25 °C
	Fixed installation	- 40 °C
	Maximum permissible operating temperature of the conductor	90 °C
	Short-circuit temperature of the conductor	250 °C
Mechanical	Tensile load	Up to 15 N/mm <sup>2</sup>
	Minimum bending radii	According to DIN VDE 0298 part 3
	Reeling operation	No restriction. Consult the manufacturer if speed exceeds 180 m/min
	Festoon systems	Up to 240 m/min
Chemical	Resistance to oil	According to VDE / IEC standard
	Weather resistance	Unrestricted use outdoor and indoor, UV resistant, moisture resistant.

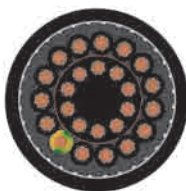

If the environment reaches - 40 °C, Palazzo can provide a special version of this cable (differentiated from the standard one by the "-K" add to the code name), which is constructed with a special rubber compound that can face this condition. For temperature down to - 40 °C we suggest to use the Panzerflex-K. To allow this cable operating at - 40°C we use an outer-sheath compound that is less resistant to abrasion and tear so please contact our sales department for more information regarding application.

**Table 1: PANZERFLEX-L 0.6/1 kV (N)SHTÖU-JZ / -OZ control cables**

N. of cores and nominal section (n-mm <sup>2</sup> )	Conductor		Overall diameter		Net weight approx. kg/km	Maximum permissible tensile force N	Current carrying capacity at 30 °C *					Short circuit current 80 ° to 200 °C kA·1 sec.
	D.C. resist. at 20 °C Ohm/km	nom. diam. mm	min. mm	max. mm			Laid straight A	Suspended in free air A	Spiral or 1 layer A	2 layer A	3 layer A	
3x1.5	13,7	1,5	12,4	14,5	255	68	23	24	18	14	11	0,19
4x1.5	13,7	1,5	13,1	15,2	285	90	23	24	18	14	11	0,19
5x1.5	13,7	1,5	14,0	16,0	320	113	23	24	18	14	11	0,19
7x1.5	13,7	1,5	15,8	17,9	415	158	23	24	18	14	11	0,19
12x1.5	13,7	1,5	19,1	21,2	585	270	23	24	18	14	11	0,19
18x1.5	13,7	1,5	21,6	23,7	765	405	23	24	18	14	11	0,19
24x1.5	13,7	1,5	25,6	27,6	1040	540	23	24	18	14	11	0,19
30x1.5	13,7	1,5	26,6	28,7	1140	675	23	24	18	14	11	0,19
36x1.5	13,7	1,5	28,6	31,8	1370	810	23	24	18	14	11	0,19
3x2.5	8,21	2,0	13,4	15,5	310	113	30	32	24	18	15	0,32
4x2.5	8,21	2,0	14,3	16,3	355	150	30	32	24	18	15	0,32
5x2.5	8,21	2,0	15,2	17,3	410	188	30	32	24	18	15	0,32
7x2.5	8,21	2,0	18,1	20,2	570	263	30	32	24	18	15	0,32
12x2.5	8,21	2,0	21,1	23,2	760	450	30	32	24	18	15	0,32
18x2.5	8,21	2,0	24,7	26,8	1070	675	30	32	24	18	15	0,32
24x2.5	8,21	2,0	28,6	31,8	1450	900	30	32	24	18	15	0,32
30x2.5	8,21	2,0	30,0	33,0	1600	1125	30	32	24	18	15	0,32
36x2.5	8,21	2,0	31,8	35,0	1850	1350	30	32	24	18	15	0,32
7x4	5,09	2,4	20,6	22,6	1850	420	41	43	33	25	20	0,51
12x4	5,09	2,4	25,0	27,0	1851	720	41	43	33	25	20	0,51
18x4	5,09	2,4	28,4	30,4	1852	1080	41	43	33	25	20	0,51

\*Tabulated values are valid up to three loaded conductors with or without earth.  
Derating factor shall be used for multicore cables depending on loaded conductors. See page 49.

The Tensile Load on control cables is calculated considering the limit of 15N/mm<sup>2</sup> instead of the standard 20N/mm<sup>2</sup>. This is due to the construction of these multi-core cables. For higher Tensile Load please consider to use our VS type as it is provided of a central Kevlar® strainer that allows much higher tensile loads.

### Cable type

**PANZERFLEX-SIGNAL 0.6/1 kV**  
(N)SHTÖU-JZ / -OZ suitable for festoon system and simple reeling operation

### Main application

Flexible signal/control for use on connecting movable parts of machine tools and any material handling equipment  
Suitable for signalling supply on festoon systems with fast movement with strong acceleration, suitable also for simple reeling.

### Construction

Conductor:	Tinned copper conductor, flexible cl.5 IEC 60228 Specially designed for mobile application
Insulation:	EPR compound better than 3GI3 Specially developed crushproof compound with improved electrical and mechanical characteristics
Cores identification:	Black with printed numbers with or without 1 green/yellow Each cores consecutively numbered
Shield (on single core or pair):	Tinned copper braid screen At least 70 % on cores At least 80 % on pairs
Pairs (if any):	Two cores layed-up Textile filler in the interstices to mantein good geometrical characteristics
Laying-up:	Short lay length for better flexibility ≤7 times the laying-up cores diameter (in maximum 3 layer for multicores cables)
Separation (if any):	Tape(s)
Inner sheath:	Polychloroprene rubber based compound Better than GM1b
Antitwisting protection:	Synthetic yarns Firmly bonded between inner and outer sheath
Outer sheath:	Black polychloroprene rubber compound UV resistant oil and chemical resistant better then 5GM2
Marking:	PALAZZO - PANZERFLEX 0,6/1 kV n. of cores/pairs x cross section

### Parameters

<b>Electrical</b>	Rated voltage	U <sub>0</sub> /U = 0,6/1 kV
	Maximum permissible operating voltage in AC systems	U <sub>m</sub> = 1,2 kV
	AC test voltage over 5 minutes	2,5 kV
	Current Carrying Capacity	According to DIN VDE 0298 part 4
	Bus compatibility	Cable with twisted and individually shielded pairs can be used for bus systems
<b>Thermal</b>	Fully flexible operation	- 25 °C
	Fixed installation	- 40 °C
	Maximum permissible operating temperature of the conductor	90 °C
	Short-circuit temperature of the conductor	250 °C
<b>Mechanical</b>	Tensile load	Up to 15 N/mm <sup>2</sup>
	Minimum bending radii	According to DIN VDE 0298 part 3
	Reeling operation	Up to 60 m/min
	Festoon systems	Up to 180 m/min
<b>Chemical</b>	Resistance to oil	According to VDE / IEC standard
	Weather resistance	Unrestricted use outdoor and indoor, UV resistant, moisture resistant.



If the environment reaches - 40 °C, Palazzo can provide a special version of this cable (differentiated from the standard one by the "K" add to the code name), which is constructed with a special rubber compound that can face this condition.  
For temperature down to - 40 °C we suggest to use the Panzerflex-K. To allow this cable operating at - 40°C we use an outer-sheath compound that is less resistant to abrasion and tear so please contact our sales department for more information regarding application.

**Table 1: PANZERFLEX-signal 0.6/1 kV (N)SHTÖU-JZ / -OZ**

N. of cores and nominal section (n-mm <sup>2</sup> )	Conductor		Overall diameter		Net weight approx. kg/km	Maximum permissible tensile force N	Current carrying capacity at 30 °C *					Short circuit current 80 ° to 200 °C kA·1 sec.
	D.C. resist. at 20 °C Ohm/km	nom. diam. mm	min. mm	max. mm			Laid straight A	Suspended in free air A	Spiral or 1 layer A	2 layer A	3 layer A	
3x(2x1.0)C	20,0	1,3	20,9	23,0	670	90	-	-	-	-	-	0,13
3x(2x1.5)C	13,7	1,5	21,4	23,5	740	135	-	-	-	-	-	0,19
6x(2x1.0)C	20,0	1,3	26,9	29,0	1080	180	-	-	-	-	-	0,13
6x(2x1.5)C	13,7	1,5	28,3	30,3	1210	270	-	-	-	-	-	0,19
6x(2x2.5)C	8,21	2	30,6	33,6	1570	450	-	-	-	-	-	0,32
19x2,5+5x1(c)	8,21	2	30,6	33,8	1580	713	30	32	24	18	15	0,32
19x2,5+5x1,5(c)	8,21	2	30,6	33,8	1630	713	30	32	24	18	15	0,32
25x2,5+5x1(c)	8,21	2	32,6	35,8	1820	938	30	32	24	18	15	0,32
25x2,5+5x1,5(c)	8,21	2	32,6	35,8	1850	938	30	32	24	18	15	0,32
26x2,5+10x1(c)	8,21	2	36,2	39,4	2150	975	30	32	24	18	15	0,32

\*Tabulated values are valid up to three loaded conductors with or without earth.  
Derating factor shall be used for multicore cables depending on loaded conductors. See page 49.

The Tensile Load on control cables is calculated considering the limit of 15N/mm<sup>2</sup> instead of the standard 20N/mm<sup>2</sup>. This is due to the construction of these multi-core cables. For higher Tensile Load please consider to use our VS type as it is provided of a central Kevlar® strainer that allows much higher tensile loads.



### Cable type

#### FLEXIFLAT 450/750 V

(N)GFLGÖU- J/ (N)GFLGÖU- JZ flat rubber cables for festoon system

### Main application

Flexible power and control cables for use on connecting movable parts of machine tools and any material handling equipment. Suitable for power and signalling supply on festoon systems with fast movement with strong acceleration.

### Construction

Conductor:	Plain or tinned copper conductor, flexible to IEC 60228 cl.6 up to 6 mm <sup>2</sup> , cl. 5 from 10 mm <sup>2</sup> Specially designed for mobile application
Insulation:	EPR compound better than 3GI3 Specially developed compound with improved electrical and mechanical characteristics
Cores identification:	Colours according to HD 308 S2 Standard colours: - 4 cores: green/yellow, brown, black, grey - ≥ 6 cores: black with printed numbers + green/yellow Green/yellow approximatly in the middle
Core arrangement:	Parallel, starting from 12 cores in parallel bundle Green/yellow approximatly in the middle of the cable
Separation (if any):	Tape(s)
Outer sheath:	Black polychloroprene rubber compound UV resistant, oil and chemical resistant better then 5GM2
Marking:	PALAZZO - FLEXIFLAT 450/750 V n. of cores x cross section

### Parameters

Electrical	Rated voltage	U <sub>0</sub> /U = 450/750 V
	Maximum permissible operating voltage in AC systems	U <sub>m</sub> = 900 V
	AC test voltage over 5 minutes	2,5 kV
	Current Carrying Capacity	According to DIN VDE 0298 part 4
	Bus compatibility	Cable with twisted and individually shielded pairs can be used for bus systems
Thermal	Fully flexible operation	- 25 °C
	Fixed installation	- 40 °C
	Maximum permissible operating temperature of the conductor	90 °C
	Short-circuit temperature of the conductor	250 °C
Mechanical	Tensile load	Up to 15 N/mm <sup>2</sup>
	Minimum bending radii	According to DIN VDE 0298 part 3
	Reeling operation	NO APPLICATION
	Festoon systems	Up to 180 m/min
Chemical	Resistance to oil	According to VDE / IEC standard
	Weather resistance	Unrestricted use outdoor and indoor, UV resistant, moisture resistant.

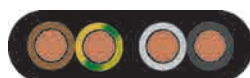
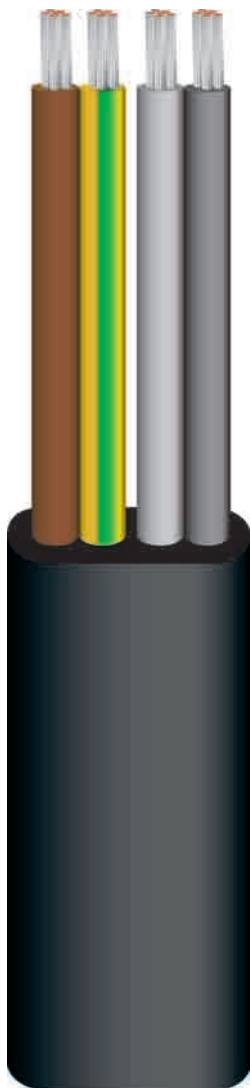

**Table 1: FLEXIFLAT 450/750 V (N)GFLGÖU-JZ**

N. of cores and nominal cross section (n·mm <sup>2</sup> )	Nominal conductor diameter (mm <sup>2</sup> )	Max. D. C. electr. res. at 20 °C (Ohm/km)	Nominal overall dimensions WxTh (mm)	Weight for 1000 m (kg/km)	Max. permissible tensile load (N)
3 x 4 x 1.5	1.5	13.7	15 x 35	810	270
4 x 4 x 1.5	1.5	13.7	15 x 45	1055	360
3 x 4 x 2.5	2.0	8.21	17 x 41	1125	450
4 x 4 x 2.5	2.0	8.21	17 x 53	1465	600
4 x 10	4.2	1.95	11 x 35	870	600
4 x 16	5.4	1.24	13 x 41	1250	960
4 x 25	6.7	0.795	14,9 x 48	1785	1500
4 x 35	8.2	0.565	16,8 x 52	2330	2100
4 x 50	9.6	0.393	19,5 x 61	3200	3000
4 x 70	11.6	0.277	22 x 70	4280	4200
4 x 95	13.2	0.210	24 x 79	5550	5700

With integrated fibre-optics on request

## Festoonfiberflex loose tube optical cable for data transmission

### Cable type

#### FESTOONFIBERFLEX

Rubber sheathed flexible fibre-optics cable

### Main application

Flexible signal and data transmission cables for use on cranes and material handling equipment, suitable for use on festoon systems, simple reeling  
Fibre-optics for absolute immunity from electrical interferences.

### Construction

Fibre optics:	Core diameter: 50 µm, 62,5 µm, 9µm. Cladding 125 µm, coating 250 µm Main type 62,5/125, the others on request
Tubes:	Basic material PBTF Hollow core with filling compound
Cores identification:	Color code for tubes (pilot directional system) Different fibre colour in case of 2 or 3 fibres per tube
Tubes arrangement:	Six tubes specially laid-up around a central support element - main construction 6 fibre-optics (1 fibre per tube) - on request 12, 18 fibre-optics (2 or 3 fibres per tube)
Antitwisting protection:	Double layer of synthetic yarns of aramidic fibres
Outer sheath:	Black polychloroprene based compound UV resistant, oil and chemical resistant better than 5GM2 compound
Marking:	PALAZZO - FESTOONFIBERFLEX n. of fibres & type

### Parameters

Optical		Graded index fibre		Monomode fibre
		50/125	62,5 /125	E9/125
Max attenuation at 850 nm	dB/km			
Max attenuation at 1300 nm	dB/km	2,8	3,0	-
Max attenuation at 1550 nm	dB/km	0,8	0,9	0,4
Bandwidth at 850 / 1300 nm	MHz	≥ 400/800	≥ 160/500	0,3
Numerical aperture		0,200 ± 0,02	0,275 ± 0,02	-
Chromatic dispersion				
at 1300 nm	ps/(nm x km)	-	-	< 3,5
at 1550 nm	ps/(nm x km)	-	-	< 18
Thermal		Fully flexible operation		
		- 20 °C to +60 °C		
		Fixed installation		
		- 40 °C to +80 °C		
Mechanical		Tensile load		
		1200 N max		
		Minimum bending radii		
		200 mm		
		Reeling operation		
		Up to 120 m/min (NO RANDOM WOUND REEL)		
		Festoon /cable tender systems		
		Up to 240 m/min		
Chemical		Resistance to oil		
		According to VDE / IEC standard		
		Weather resistance		
		Unrestricted use outdoor and indoor, UV resistant, moisture resistant.		



## Festoonfiberflex loose tube optical cable for data transmission

Table 1: FESTOONFIBERFLEX

N. of fibers and dimension	Fibre x tubes  (n)	Overall diameter		Net weight approx.  kg/km	Max. permissible tensile force  N
		min. value mm	max. value mm		
6G62,5/125*	1	13,0	15,0	230	1200
6G50/125	1	13,0	15,0	230	1200
6E9/125	1	13,0	15,0	230	1200
12G62,5/125	2	13,0	15,0	230	1200
12G50/125	2	13,0	15,0	230	1200
12E9/125	2	13,0	15,0	230	1200
18G62,5/125	3	13,5	15,5	230	1200
18G50/125	3	13,5	15,5	230	1200
18E9/125	3	13,5	15,5	230	1200

\*Main type





## **VERTICAL APPLICATION AND HIGH TENSILE LOAD**

### Cable type

**PANZERFLEX-VS 0.6/1 kV**  
NSHTÖU-J/ -0; NSHTÖU -JZ / OZ tough rubber sheathed cable

### Main application

Extra heavy duty power and control cables. For application with high mechanical stresses (i.e.: tensile and torsion simultaneously applied).

These cables have a tensile load of minimum 2000 N (standard for control cables) and are indicated to be used on equipment such as container crane spreader reels, rack and pinion elevators using shave guided cables, pendant station, all tenders etc.

### Construction

Conductor:	Tinned copper conductor, extraflexible cl.6 IEC 60228 up to 6 mm <sup>2</sup> , flexible cl.5 IEC 60228 from 10 mm <sup>2</sup> Both the class of conductors are specially designed for mobile application
Insulation:	EPR compound better than 3GI3 special compound with improved electrical and mechanical characteristics
Cores identification:	Colours according to according to DIN VDE 0293 part 308 / HD 308 S2 Standard colours: - 4 cores: green/yellow, brown, black, grey - 5 cores: green/yellow, blue, brown, black, grey - ≥ 6 cores: black with printed numbers, green/yellow in the outer layer
Central strainer (if any):	Made of aramidic yarns To be used as support element
Laying-up:	Short lay length for better flexibility ≤ 6,5 times the laying-up cores diameter in maximum 3 layer (for control cables)
Separation (if any):	Tape(s)
Inner sheath:	Polychloroprene rubber based compound Better than 5GM2
Antitwisting protection:	Textile braid of synthetic yarns Firmly vulcanized bonded between inner and outer sheath
Outer sheath:	Yellow polychloroprene rubber compound Oil and chemical resistant, 5GM3/5GM5 abrasion and notch resistant
Marking:	PALAZZO - PANZERFLEX-VS 0,6/1 kV n. of cores x cross section

### Parameters

Electrical	Rated voltage	U <sub>0</sub> /U= 0,6/1 kV
	Maximum permissible operating voltage in AC systems	U <sub>m</sub> = 1,2 kV
	AC test voltage over 5 minutes	3,5 kV
	Current Carrying Capacity	According to DIN VDE 0298 part 4
Thermal	Fully flexible operation	- 25 °C
	Fixed installation	- 40 °C
	Maximum permissible operating temperature of the conductor	90 °C
	Short-circuit temperature of the conductor	250 °C
Mechanical	Tensile load	Up to 20 N/mm <sup>2</sup> with a minimum of 2000 N
	Minimum bending radii	According to DIN VDE 0298 part 3
	Reeling operation	No restriction. Consult the manufacturer if speed exceeds 180 m/min
Chemical	Resistance to oil	According to VDE / IEC standard
	Weather resistance	Unrestricted use outdoor and indoor, UV resistant, moisture resistant.



## Power and control cables for extreme application according to VDE 0250 part. 814

Table 1: PANZERFLEX-VS 0.6/1 kV NSHTÖU -J / -O; NSHTÖU -JZ / OZ

N. of cores and nominal section (n-mm <sup>2</sup> )	Conductor		Overall diameter		Net weight approx. kg/km	Maximum permissible tensile force N	Current carrying capacity at 30 °C *					Short circuit current 80 ° to 200 °C kA·1 sec.
	D.C. resist. at 20 °C Ohm/km	nom. diam. mm	min. mm	max. mm			Laid straight A	Suspended in free air A	Spiral or 1 layer A	2 layer A	3 layer A	
7G1.5	13,7	1,6	17,3	19,4	495	2000	23	24	18	14	11	0,19
12G1.5	13,7	1,6	23,6	25,7	885	2000	23	24	18	14	11	0,19
18G1.5	13,7	1,6	24,2	26,3	940	2000	23	24	18	14	11	0,19
24G1.5	13,7	1,6	28,8	30,9	1300	2000	23	24	18	14	11	0,19
30G1.5	13,7	1,6	30,8	34,0	1430	2000	23	24	18	14	11	0,19
36G1.5	13,7	1,6	31,0	34,2	1600	2000	23	24	18	14	11	0,19
7G2.5	8,21	2,1	19,6	21,6	650	2000	30	32	24	18	15	0,32
12G2.5	8,21	2,1	27,4	29,5	1230	2000	30	32	24	18	15	0,32
18G2.5	8,21	2,1	28,5	30,6	1340	2000	30	32	24	18	15	0,32
24G2.5	8,21	2,1	33,4	36,6	1880	2000	30	32	24	18	15	0,32
30G2.5	8,2	2,1	37,0	40,2	2310	2000	30	32	24	18	15	0,32
36G2.5	8,21	2,1	37,2	40,4	2350	2000	30	32	24	18	15	0,32
7G4	5,09	2,7	23,3	25,4	945	2000	41	43	33	25	20	0,51
12G4	5,09	2,7	32,4	35,6	1830	2000	41	43	33	25	20	0,51
18G4	5,09	2,7	32,8	36,0	2020	2000	41	43	33	25	20	0,51
4G10	1,95	4,2	25,1	27,1	1140	2000	74	78	59	45	36	1,3
4G16	1,24	5,4	28,0	30,1	1520	2000	99	104	79	60	49	2,0
4G25	0,795	6,6	32,8	36,0	2160	2000	131	138	105	80	64	3,2
4G35	0,565	8,0	35,8	39,0	2780	2800	162	170	130	99	79	4,5
4G50	0,393	9,3	41,8	45,0	3700	4000	202	212	162	123	99	6,4
4G70	0,277	11,2	46,2	49,4	4800	5600	250	263	200	153	123	9,0
4G95	0,210	13,0	53,0	57,5	6300	7600	301	316	241	184	147	12,2

\*Tabulated values are valid up to three loaded conductors with or without earth.

Derating factor shall be used for multicore cables depending on loaded conductors. See page 49.



### Cable type

**PANZERLITE 0.6/1 kV**  
Polyurethane double sheathed cables

### Main application

Extra heavy duty control cables. For application with high mechanical stresses (i.e.: tensile and torsion simultaneously applied). This cable has been developed and designed in order to meet special conditions of application, in particular where small dimensions and light weight are mandatory.

Among its main features we can define:

- . small dimension
- . lighter weight
- . excellent flexibility
- . high operating speed (up to 240m/1')
- . excellent mechanical performances

### Construction

Conductor:	Plain copper conductor, extraflexible better than cl.6 IEC 60228 Specially designed for mobile application.
Insulation:	Thin thickness made of special tecnopolymer Special compound with improved electrical and mechanical characteristics
Cores identification:	White with printed numbers
Central strainer:	Made of aramidic yarns To be used as support element
Laying-up:	Short lay length for better flexibility In maximum 3 layer
Separation (if any):	Tape(s)
Inner sheath:	Made of special polyurethane A combination of high flexibility characteristics with improved abrasion and tear resistance characteristics
Antitwisting protection:	Textile braid of synthetic yarns Firmly bonded between inner and outer sheath
Outer sheath:	Made of Yellow special polyurethane A combination of high flexibility characteristics with improved abrasion and tear resistance characteristics
Marking:	PALAZZO - PANZERLITE 0,6/1 kV n. of cores x cross section

### Parameters

<b>Electrical</b>	Rated voltage	U <sub>0</sub> /U= 0,6/1 kV
	Maximum permissible operating voltage in AC systems	U <sub>m</sub> = 1,2 kV
	AC test voltage over 5 minutes	2,5 kV
	Current Carrying Capacity	According to DIN VDE 0298 part 4
<b>Thermal</b>	Fully flexible operation	- 30 °C
	Fixed installation	- 40 °C
	Maximum permissible operating temperature of the conductor	90 °C
	Short-circuit temperature of the conductor	200 °C
<b>Mechanical</b>	Tensile load	2000 N (up to 4000 N on request)
	Minimum bending radii	According to DIN VDE 0298 part 3
	Reeling operation '250 °C	No restriction. Consult the manufacturer if speed exceeds 240 m/min
<b>Chemical</b>	Resistance to oil	According to VDE / IEC standard
	Weather resistance	Unrestricted use outdoor and indoor, UV resistant, moisture resistant.

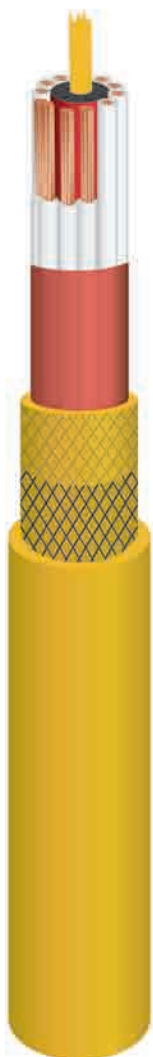

Table 1: PANZERLITE 0.6/1 kV

N. of cores and nominal section (n-mm <sup>2</sup> )	Conductor		Overall diameter		Net weight approx. kg/km	Maximum permissible tensile force N	Laid straight A	Current carrying capacity at 30 °C *					Short circuit current 80 ° to 200 °C kA·1 sec.
	D.C. resist. at 20 °C Ohm/km	nom. diam. mm	min. mm	max. mm				Suspended in free air A	Spiral or 1 layer A	2 layer A	3 layer A		
18x2.5	8,21	2,2	21,0	24,0	805	2000	30	32	24	18	15	0,32	
37x2.5	8,21	2,2	29,5	32,5	1540	4000	30	32	24	18	15	0,32	
44x2.5	8,21	2,2	32,5	35,5	1780	4000	30	32	24	18	15	0,32	

\*Tabulated values are valid up to three loaded conductors with or without earth.

Derating factor shall be used for multicore cables depending on loaded conductors. See page 49.

Other sizes or configurations are available on specific request.



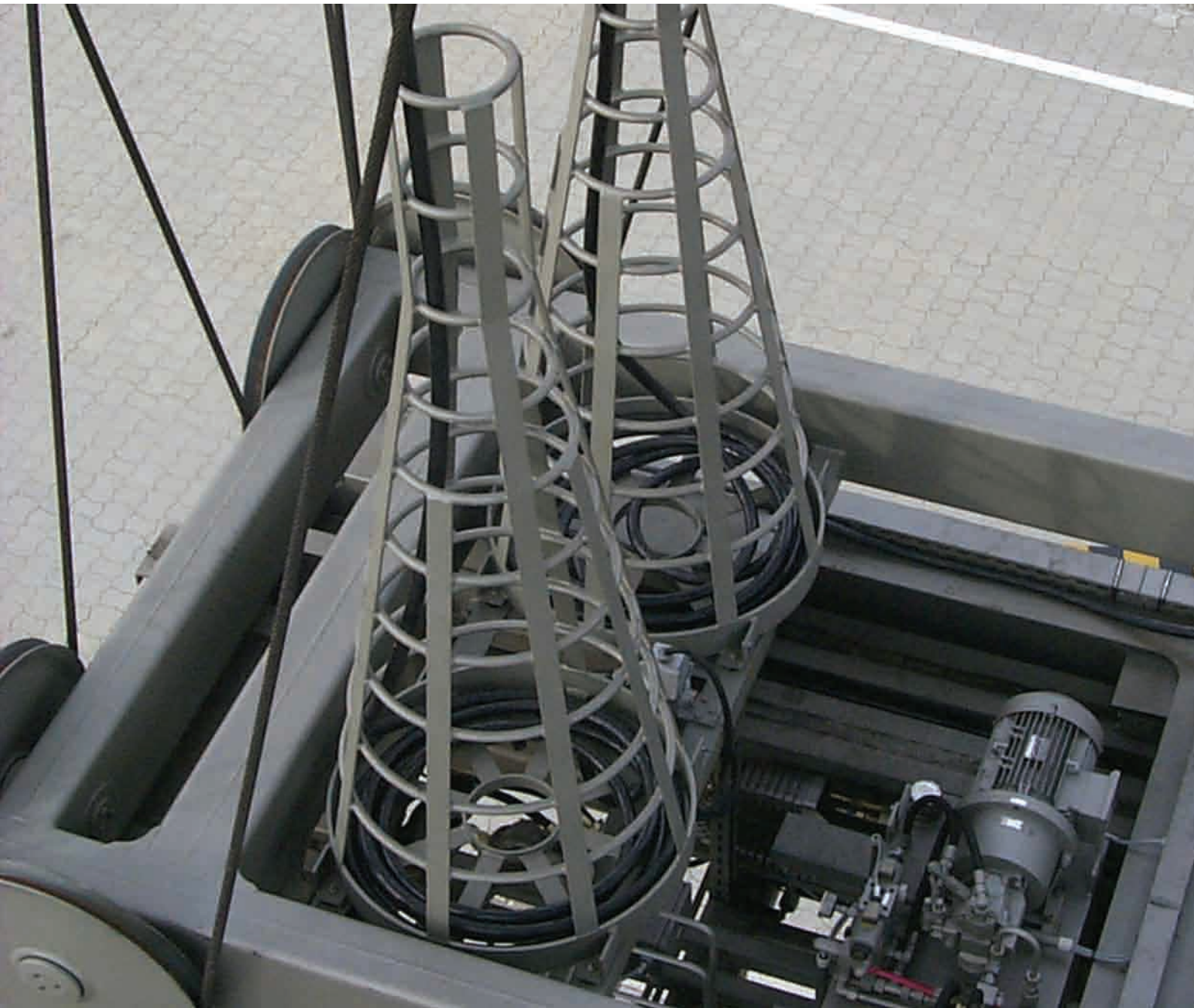

## BASKET APPLICATION

### Cable type

**BASKETHEAVYFLEX 300/500 V**  
3GRDGÖU for gravity-fed collector basket operation

### Main application

For vertical operation with high mechanical stress, suitable to be collected in gravity-fed collector basket.

### Construction

Conductor:	Tinned copper conductor, flexible cl.5 IEC 60228 Specially designed for mobile application
Insulation:	EPR compound better than 3GI3 Specially developed compound with improved mechanical characteristics
Cores identification:	Black with printed numbers+1 green/yellow Each cores consecutively numbered (the triple with green/yellow core in the outer layer)
Triples:	Three cores layed-up with suitable tape(s) Textile filler in the interstices to maintain good geometrical characteristics
Central strainer:	Made of aramidic yarns To be used as support element with a minimum tensile strength of 10 kN
Laying-up:	Short lay length for better flexibility ≤ 8 times the laying-up bundle diameter
Separation (if any):	Tape(s)
Outer sheath:	Special CSP compound High density specially developed compound UV resistant, lubricants resistant
Marking:	PALAZZO - BASKETHEAVYFLEX 300/500 V n. of triples x cross section

### Parameters

Electrical	Rated voltage	U <sub>0</sub> /U= 300/500 V
	Maximum permissible operating voltage in AC systems	U <sub>m</sub> = 550 V
	AC test voltage over 5 minutes	2,0 kV
Thermal	Fully flexible operation	- 25 °C
	Fixed installation	- 40 °C
	Maximum permissible operating temperature of the conductor	90 °C
	Short-circuit temperature of the conductor	250 °C
Mechanical	Tensile load	Up to 15 N/mm <sup>2</sup> with minimum 2000 N
	Travel speed	Up to 160 m/min
Chemical	Resistance to oil	According to VDE / IEC standard
	Weather resistance	Unrestricted use outdoor and indoor, UV resistant, moisture resistant.



**Flexible cables for gravity-fed collector in basket in line with DIN VDE 0250 part. 814**
**Table 1: BASKETHEAVYFLEX 300/500 V 3GRDGÖU**

N. of cores and nominal section n-mm <sup>2</sup>	Conductor		Overall diameter		Net weight approx. kg/km	Maximum permissible tensile force N	Current carrying capacity at 30 °C					Short circuit current 80 ° to 200 °C kA·1 sec.
	D.C. resist. at 20 °C Ohm/km	nom. diam. mm	min. mm	max. mm			Laid straight A	Suspended in free air A	Spiral or 1 layer A	2 layer A	3 layer A	
8x3x2.5	8,21	2,1	36,0	41,0	2450	900	-	-	-	-	-	0,32
12x3x2.5	8,21	2,1	39,5	44,5	3230	1350	-	-	-	-	-	0,32
14x3x2.5	8,21	2,1	44,0	49,0	3560	1575	-	-	-	-	-	0,32
16x3x2.5	8,21	2,1	46,5	51,5	3970	1800	-	-	-	-	-	0,32
18x3x2.5	8,21	2,1	48,5	53,5	4370	2025	-	-	-	-	-	0,32
8x3x3.3	6,11	2,6	36,0	41,0	2660	1190	-	-	-	-	-	0,42
12x3x3.3	6,11	2,6	39,5	44,5	3510	1790	-	-	-	-	-	0,42
14x3x3.3	6,11	2,6	44,0	49,0	3930	2080	-	-	-	-	-	0,42
16x3x3.3	6,11	2,6	46,5	51,5	4320	2380	-	-	-	-	-	0,42
18x3x3.3	6,11	2,6	48,5	53,5	4760	2680	-	-	-	-	-	0,42





## MEDIUM VOLTAGE REELING AND FESTOONING





### Cable type

**PANZERFLEX-ELX 3,6 ÷ 12/20 kV**  
(N)TSCGEWÖU - H.V. reeling cable 6 to 20 kV

### Main application

Flexible H.V. reeling power cables for use on connecting movable parts of machine tools and any material handling equipment (i.e. Stacker/reclaimer, ship to shore crane, container crane, excavators, also suitable for festoon system).

Perfectly suitable for any energy supply on cable reels systems associated from high to extreme mechanical stresses, frequent bending/torsional operation and fast movement with strong acceleration.

### Construction

Conductor:	Tinned copper conductor, flexible cl.5 IEC 60228 Specially designed for mobile application
Insulation:	Micro filtered HEPR rubber compound better than 3GI3 New specially developed compound with improved electrical and mechanical characteristics
Cores identification:	Main cores: natural colour with black semiconductive layer Splitted earth cores: identified by position and covered with special black semiconductive compound
Field control:	- Conductor screen: semiconductive layer - Insulation screen: semiconductive layer of special compound Applied with insulation
Laying-up:	Short lay length for better flexibility and mechanical characteristics ≤ 8 times the laying-up cores diameter, three cores design with protective earth cores split in 3 interstitial areas
Separation (if any):	Tape(s)
Inner sheath:	Polychloroprene rubber based compound Special developed with improved mechanical characteristics
Antitwisting protection:	Textile braid of synthetic yarns Firmly bonded between inner and outer sheath
Outer sheath:	Red polychloroprene rubber compound UV resistant, oil and chemical resistant better than 5GM3 compound
Marking:	PALAZZO - PANZERFLEX-ELX rated voltage $nc \times$ cross section year of manufacturing

### Parameters

Electrical	Rated voltage	$U_0/U = 3,6/6$ kV to 12/20 kV*
	Maximum permissible operating voltage in AC systems	$U_m = 7,2$ kV to 24 kV
	AC test voltage over 5 minutes	11 kV to 29 kV according to VDE 0250 part 813
	Current Carrying Capacity	According to DIN VDE 0298 part 4
EMC	Simmetrical design + narrow production tolerances	Very low interference
Thermal	Fully flexible operation	- 30 °C
	Fixed installation	- 40 °C
	Maximum permissible operating temperature of the conductor	90 °C
	Short-circuit temperature of the conductor	250 °C
Mechanical	Tensile load	Up to 20 N/mm <sup>2</sup>
	Minimum bending radii	According to DIN VDE 0298 part 3
	Reeling operation	No restriction. Consult the manufacturer if speed exceeds 180 m/min
	Festoon systems	Up to 120 m/min
Chemical	Resistance to oil	According to VDE / IEC standard
	Weather resistance	Unrestricted use outdoor and indoor, UV resistant, moisture resistant.

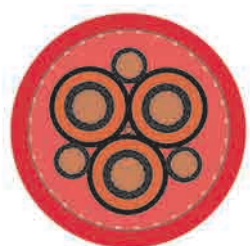



Table 1: PANZERFLEX-ELX 3.6 ÷ 12/20 kV (N)TSCGEWÖU

N. of cores and nominal section n-mm <sup>2</sup> +n-nm <sup>2</sup> /3	Main conductor		Protective earth cond. nom. diam. mm	Overall diameter		Net weight approx. kg/km	Maximum permissible tensile force N	Current carrying capacity at 30 °C				Short circuit current 80 ° to 200 °C kA·1 sec.
	D.C. resist. at 20 °C Ohm/km	nom. diam. mm		min. mm	max. mm			Laid straight A	Spiral or 1 layer A	2 layer A	3 layer A	
<b>3,6/6 kV</b>												
3x25+3x25/3	0,795	6,6	4,0	38,5	41,5	2460	1500	131	105	80	64	3,2
3x35+3x25/3	0,565	8,0	4,0	41,2	44,2	2970	2100	162	130	99	79	4,5
3x50+3x25/3	0,393	9,3	4,0	44,0	47,0	3500	3000	202	162	123	99	6,4
3x70+3x35/3	0,277	11,2	4,9	48,1	51,1	4460	4200	250	200	153	123	9,0
3x95+3x50/3	0,210	13,0	5,4	52,7	56,7	5560	5700	301	241	184	147	12,2
3x120+3x70/3	0,164	15,0	6,6	57,0	61,0	6930	7200	352	282	215	172	15,4
3x150+3x70/3	0,132	16,9	6,6	62,7	66,7	8190	9000	404	323	246	198	19,2
3x185+3x95/3	0,108	18,3	8,0	66,8	70,8	9750	11100	461	369	281	226	23,7
3x240+3x120/3	0,0817	20,5	9,3	73,9	77,9	12450	14400	540	432	329	265	30,7
<b>6/10 kV</b>												
3x25+3x25/3	0,795	6,6	4,0	39,4	42,4	2530	1500	131	105	80	64	3,2
3x35+3x25/3	0,565	8,0	4,0	42,0	45,0	3050	2100	162	130	99	79	4,5
3x50+3x25/3	0,393	9,3	4,0	44,8	47,8	3590	3000	202	162	123	99	6,4
3x70+3x35/3	0,277	11,2	4,9	48,4	52,4	4550	4200	250	200	153	123	9,0
3x95+3x50/3	0,210	13,0	5,4	53,5	57,5	5670	5700	301	241	184	147	12,2
3x120+3x70/3	0,164	15,0	6,6	57,8	61,8	7040	7200	352	282	215	172	15,4
3x150+3x70/3	0,132	16,9	6,6	63,5	67,5	8310	9000	404	323	246	198	19,2
3x185+3x95/3	0,108	18,3	8,0	67,4	71,4	9820	11100	461	369	281	226	23,7
3x240+3x120/3	0,0817	20,5	9,3	74,8	78,8	12600	14400	540	432	329	265	30,7
<b>8,7/15 kV</b>												
3x25+3x25/3	0,795	6,6	4,0	42,8	45,8	2840	1500	139	111	85	68	3,2
3x35+3x25/3	0,565	8,0	4,0	45,5	48,5	3380	2100	172	138	105	84	4,5
3x50+3x25/3	0,393	9,3	4,0	48,3	51,3	3940	3000	215	172	131	105	6,4
3x70+3x35/3	0,277	11,2	4,9	53,1	57,1	5080	4200	265	212	162	130	9,0
3x95+3x50/3	0,210	13,0	5,4	57,0	61,0	6100	5700	319	255	195	156	12,2
3x120+3x70/3	0,164	15,0	6,6	62,9	66,9	7730	7200	371	297	226	182	15,4
3x150+3x70/3	0,132	16,9	6,6	67,0	71,0	8800	9000	428	342	261	210	19,2
3x185+3x95/3	0,108	18,3	8,0	70,0	74,0	10230	11100	488	390	298	239	23,7
3x240+3x120/3	0,0817	20,5	9,3	77,4	81,4	13020	14400	574	459	350	281	30,7
<b>12/20 kV</b>												
3x25+3x25/3	0,795	6,6	4,0	48,0	51,0	3360	1500	139	111	85	68	3,2
3x35+3x25/3	0,565	8,0	4,0	51,4	55,4	4070	2100	172	138	105	84	4,5
3x50+3x25/3	0,393	9,3	4,0	54,2	58,2	4660	3000	215	172	131	105	6,4
3x70+3x35/3	0,277	11,2	4,9	58,3	62,3	5730	4200	265	212	162	130	9,0
3x95+3x50/3	0,210	13,0	5,4	63,7	67,7	7020	5700	319	255	195	156	12,2
3x120+3x70/3	0,164	15,0	6,6	68,0	72,0	8470	7200	371	297	226	182	15,4
3x150+3x70/3	0,132	16,9	6,6	73,9	77,9	9890	9000	428	342	261	210	19,2
3x185+3x95/3	0,108	18,3	8,0	77,0	81,0	11370	11100	488	390	298	239	23,7
3x240+3x120/3	0,0817	20,5	9,3	82,6	86,6	13890	14400	574	459	350	281	34,3

\*18/30 kV available on request



## Cable type

**PANZERFLEX-ELX 3,6 ÷ 12/20 kV**  
with integrated OPTICAL FIBRES- (N)TSCGEWÖU - H.V. reeling cable 6 to 20 kV

## Main application

Flexible H.V. reeling combined power and data transmission cables for use on connecting movable parts of machine tools and any material handling equipment (i.e. Stacker/reclaimer, ship to shore crane, container crane, excavators, also suitable for festoon system). Perfectly suitable for any energy supply on cable reels systems associated from high to extreme mechanical stresses, frequent bending/torsional operation and fast movement with strong acceleration.

## Construction

Conductor:	Tinned copper conductor, flexible cl.5 IEC 60228 Specially designed for mobile application
Insulation:	Micro filtered HEPR rubber compound better than 3GI3 New specially developed compound with improved electrical and mechanical characteristics
Cores identification:	Main cores: natural colour with black semiconductive layer Splitted earth cores: identified by position and covered with special black semiconductive compound
Field control:	- Conductor screen: semiconductive layer - Insulation screen: semiconductive layer of special compound Applied with insulation
Laying-up:	Short lay length for better flexibility and mechanical characteristics ≤ 8 times the laying-up cores diameter, three cores design with protective earth cores split in 2 interstitial areas
Separation (if any):	Tape(s)
Inner sheath:	Polychloroprene rubber based compound Special developed with improved mechanical characteristics
Antitwisting protection:	Textile braid of synthetic yarns Firmly bonded between inner and outer sheath
Outer sheath:	Red polychloroprene rubber compound UV resistant, oil and chemical resistant better than 5GM3 compound
Marking:	PALAZZO - PANZERFLEX-ELX rated voltage $nc \times$ cross section, fiber optics n. & type OPTICAL FIBER year of manufacturing

## Parameters

Electrical	Rated voltage	$U_0/U = 3,6/6 \text{ kV to } 12/20 \text{ kV}^*$
	Maximum permissible operating voltage in AC systems	$U_m = 7,2 \text{ kV to } 24 \text{ kV}$
	AC test voltage over 5 minutes	11 kV to 29 kV according to VDE 0250 part 813
	Current Carrying Capacity	According to DIN VDE 0298 part 4
EMC	Symmetrical design + narrow production tolerances	Very low interference
Data transmission	Fibre-optics for absolute immunity from electrical interferences. Main type: graded index 62,5/125. Available also graded index 50/125 and monomode E9/125 6 (main type), 12, 18 fibre-optics in a structure composed by 6 loose tubes (1, 2 or 3 fibres per tube)	
Thermal	Fully flexible operation	- 30 °C
	Fixed installation	- 40 °C
	Maximum permissible operating temperature of the conductor	90 °C
	Short-circuit temperature of the conductor	250 °C
Mechanical	Tensile load	Up to 20 N/mm <sup>2</sup>
	Minimum bending radii	According to DIN VDE 0298 part 3
	Reeling operation	No restriction. Consult the manufacturer if speed exceeds 180 m/min
	Festoon systems	Up to 120 m/min
Chemical	Resistance to oil	According to VDE / IEC standard
	Weather resistance	Unrestricted use outdoor and indoor, UV resistant, moisture resistant.





Table 1: PANZERFLEX-ELX + FO 3.6 ÷ 12/20 kV (N)TSCGEWÖU

N. of cores and nominal section n-mm <sup>2</sup> +n-mm <sup>2</sup> /2	Main conductor		Protective earth cond. nom. diam. mm	Overall diameter		Net weight approx. kg/km	Maximum permissible tensile force N	Current carrying capacity at 30 °C				Short circuit current 80 ° to 200 °C kA·1 sec.
	D.C. resist. at 20 °C Ohm/km	nom. diam. mm		min. mm	max. mm			Laid straight A	Spiral or 1 layer A	2 layer A	3 layer A	
<b>3,6/6 kV</b>												
3x25+2x25/2+1x(6 OF)	0,795	6,6	4,9	38,8	41,8	2490	1500	131	105	80	64	3,2
3x35+2x25/2+1x(6 OF)	0,565	8,0	4,9	41,2	44,2	2980	2100	162	130	99	79	4,5
3x50+2x25/2+1x(6 OF)	0,393	9,3	4,9	44,0	47,0	3510	3000	202	162	123	99	6,4
3x70+2x35/2+1x(6 OF)	0,277	11,2	6,6	48,1	51,1	4500	4200	250	200	153	123	9,0
3x95+2x50/2+1x(6 OF)	0,210	13,0	6,6	52,7	56,7	5580	5700	301	241	184	147	12,2
3x120+2x70/2+1x(6 OF)	0,164	15,	8,0	56,9	60,9	6950	7200	352	282	215	172	15,4
3x150+2x70/2+1x(6 OF)	0,132	16,9	8,0	62,7	66,7	8190	9000	404	323	246	198	19,2
3x185+2x95/2+1x(6 OF)	0,108	18,3	9,3	66,4	70,4	9630	11100	461	369	281	226	23,7
3x240+2x120/2+1x(6 OF)	0,0817	20,5	11,2	76,1	80,1	12770	14400	540	432	329	265	30,7
<b>6/10 kV</b>												
3x25+2x25/2+1x(6 OF)	0,795	6,6	4,9	39,5	42,5	2540	1500	131	105	80	64	3,2
3x35+2x25/2+1x(6 OF)	0,565	8,0	4,9	42,0	45,0	3060	2100	162	130	99	79	4,5
3x50+2x25/2+1x(6 OF)	0,393	9,3	4,9	44,8	47,8	3590	3000	202	162	123	99	6,4
3x70+2x35/2+1x(6 OF)	0,277	11,2	6,6	48,3	52,3	4570	4200	250	200	153	123	9,0
3x95+2x50/2+1x(6 OF)	0,210	13,0	6,6	53,5	57,5	5680	5700	301	241	184	147	12,2
3x120+2x70/2+1x(6 OF)	0,164	15,0	8,0	57,6	61,6	7020	7200	352	282	215	172	15,4
3x150+2x70/2+1x(6 OF)	0,132	16,9	8,0	63,3	67,3	8280	9000	404	323	246	198	19,2
3x185+2x95/2+1x(6 OF)	0,108	18,3	9,3	67,0	71,0	9720	11100	461	369	281	226	23,7
3x240+2x120/2+1x(6 OF)	0,0817	20,5	11,2	76,8	80,8	12880	14400	540	432	329	265	30,7
<b>8,7/15 kV</b>												
3x25+2x25/2+1x(6 OF)	0,795	6,6	4,9	42,7	45,7	2830	1500	139	111	85	68	3,2
3x35+2x25/2+1x(6 OF)	0,565	8,	4,9	45,5	48,5	3390	2100	172	138	105	84	4,5
3x50+2x25/2+1x(6 OF)	0,393	9,3	4,9	48,3	51,3	3590	3000	215	172	131	105	6,4
3x70+2x35/2+1x(6 OF)	0,277	11,2	6,6	53,1	57,1	5130	4200	265	212	162	130	9,0
3x95+2x50/2+1x(6 OF)	0,210	13,0	6,6	57,0	61,0	6120	5700	319	255	195	156	12,2
3x120+2x70/2+1x(6 OF)	0,164	15,0	8,0	62,9	66,9	7770	7200	371	297	226	182	15,4
3x150+2x70/2+1x(6 OF)	0,132	16,9	8,0	67,0	71,0	8820	9000	428	342	261	210	19,2
3x185+2x95/2+1x(6 OF)	0,108	18,3	9,3	70,0	74,0	10190	11100	488	390	298	239	23,7
3x240+2x120/2+1x(6 OF)	0,0817	20,5	11,2	78,2	83,2	13190	14400	574	459	350	281	30,7
<b>12/20 kV</b>												
3x25+2x25/2+1x(6 OF)	0,795	6,6	4,9	48,0	51,0	3360	1500	139	111	85	68	3,2
3x35+2x25/2+1x(6 OF)	0,565	8,0	4,9	51,4	55,4	4080	2100	172	138	105	84	4,5
3x50+2x25/2+1x(6 OF)	0,393	9,3	4,9	54,2	58,2	4670	3000	215	172	131	105	6,4
3x70+2x35/2+1x(6 OF)	0,277	11,2	6,6	58,3	62,3	5790	4200	265	212	162	130	9,0
3x95+2x50/2+1x(6 OF)	0,210	13,0	6,6	63,7	67,7	7040	5700	319	255	195	156	12,2
3x120+2x70/2+1x(6 OF)	0,164	15,0	8,0	68,0	72,0	8510	7200	371	297	226	182	15,4
3x150+2x70/2+1x(6 OF)	0,132	16,9	8,0	73,9	77,9	9920	9000	428	342	261	210	19,2
3x185+2x95/2+1x(6 OF)	0,108	18,3	9,3	77,0	81,0	11310	11100	488	390	298	239	23,7
3x240+3x120/2+1x(6 OF)	0,0817	20,5	11,1	82,1	87,1	13840	14400	574	459	350	281	34,3

\*18/30 kV available on request

### Cable type

#### PANZERFLAT-ELX 3 ÷ 10 kV

with or without integrated OPTICAL FIBRES - (N)3GFLCGEWÖU; H.V. reeling cable 3 to 10 kV

### Main application

Flexible H.V. reeling combined power with or without data transmission cables for use on connecting movable parts of machine tools and any material handling equipment (i.e. Stacker/reclaimer, ship to shore crane, container crane, also suitable for festoon system). Suitable for any energy supply on cable reels systems associated from mechanical stresses, frequent bending operation (IN ONE PLANE ONLY) in movement with medium acceleration.

### Construction

Conductor:	Tinned copper conductor, flexible cl.5 IEC 60228 Specially designed for mobile application
Insulation:	Micro filtered HEPR rubber compound better than 3GI3 New specially developed compound with improved electrical and mechanical characteristics
Cores identification:	Main cores: natural colour with black semiconductive layer Earth core: - of the same size of main conductor identified by yellow/green colour of insulation - splitted on the main cores
Field control:	- Conductor screen: semiconductive layer - Insulation screen: semiconductive layer of special compound Applied with insulation
Metallic screen:	Tinned copper wire braid on phase cores
Cores arrangement:	Parallel Fiber optic module (if any) in the centre
Separation (if any):	Tape(s)
Outer sheath:	Red polychloroprene based compound UV resistant, oil and chemical resistant better then 5GM3 compound
Marking:	PALAZZO - PANZERFLAT-ELX rated voltage $nc \times$ cross section year of manufacturing

### Parameters

Electrical	Rated voltage	U <sub>0</sub> /U= 1,8/3 kV to 6/10 kV
	Maximum permissible operating voltage in AC systems	U <sub>m</sub> = 3,6 kV to 12 kV
	AC test voltage over 5 minutes	6 kV to 11 kV according to VDE 0250 part 813
	Current Carrying Capacity	According to DIN VDE 0298 part 4
Data trasmission (if any)	Fibre-optics for absolute immunity from electrical interferences.	6 , 12, 18 fibre-optics
	Main type: graded index 62,5/125	In a structure composed by 6 loose tubes
	Available also graded index 50/125 and monomode E9/125	(1, 2 or 3 fibres per tube)
Thermal	Fully flexible operation	- 30 °C
	Fixed installation	- 40 °C
	Maximum permissible operating temperature of the conductor	90 °C
	Short-circuit temperature of the conductor	250 °C
Mechanical	Tensile load	Up to 15 N/mm <sup>2</sup>
	Minimum bending radii	According to DIN VDE 0298 part 3
	Reeling operation	No restriction. Consult the manufacturer if speed exceeds 180 m/min
Chemical	Resistance to oil	According to VDE / IEC standard
	Weather resistance	Unrestricted use outdoor and indoor, UV resistant, moisture resistant.

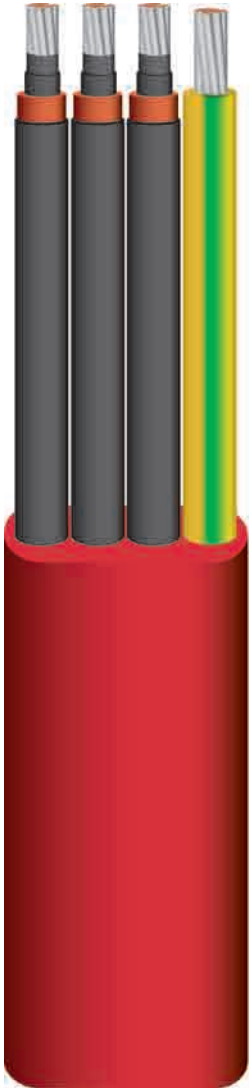







Courtesy of: REGGIANE CRANES and PLANTS - FANTUZZI GROUP - Italy



## TECHNICAL INFORMATION



## Foreword

In the following pages, you will find some major technical information organized in handling/installation and Electrical.

Our goal is provide you with all the easy, most common information in order to deal correctly with all our cables (from the project to the final handling).

Obviously we prefer if you would contact us for any specific, as our sales department and our technicians can act together in order to help you best in this way.



## BENDING RADII

Table 1

		TYPE OF USE							
		ANCHORING REEL	FESTOONS	CABLE WINDING REELS	BASKET	CABLE CARRIER CHAINS	CABLE TENDER SYSTEMS	GUIDE PULLEY SYSTEMS	
OPERATING VOLTAGE (V)	CABLE'S OVERALL DIAMETER (mm <sup>2</sup> )								
≤ 1000	< 8.0	3xOD	3xOD	5xOD	-	8xOD	7.5xOD		
	< 12.0	3xOD	4xOD	5xOD	-	9xOD	7.5xOD		
	≤ 20.0	4xOD	5xOD	5xOD	-	10xOD	7.5xOD		
	> 20.0	4xOD	5xOD	6xOD	15xOD	11xOD	7.5xOD		
> 1000	6xOD	10xOD	12xOD	-	10xOD	15xOD			

The above table gives the recommended minimum bending radii for different cable uses. Observance of these recommendations and a precise calculation of the bending radius is important as one of the most important factors of reliability. Increase on minimum bending radius has a more than proportional effect on the life of a cable because it causes stretching and internal torsions due to increased mechanical stresses in the conductors.

As the frequency of movements is important, a tighter bending radius may be considered where movement is slow and/or occasional.

Care must also be taken and limits imposed on design where pulleys or guide rollers (same radii as for collection reels) are present or where there is a flexion and torsional stress due to reel being parallel to the line of travel of the machine.

## HANDLING AND INSTALLATION

### Cable guides

After considering the correct reeling system, the cable guides became the next step to be looked at properly.

Some misuse of the handling of these guides lead to some major reeling system problems. Amongst the various guide types the best are the radius types as they provide generous bending radii with minimum cable deflection. Our last mandatory recommendation is to keep the guide exactly aligned with the payout plane of the cable: every misalignment can lead to an increase of torsion on the cable itself.

#### One way or two ways guides

A one way guide often appears even on two directions payout as it seems the most economic solution.

However a considerable increase in cable life is obtained if a two way guide is used: in fact the net torsional and “massaging” effects imparted by the guide to the cables are balanced using a symmetrical two way one. This problem doesn't occur if the reeling system is end fed. In this case the one-directional guide is in contact with the cable regardless of the direction of travel of the machine.



A part from this, the two-way guide or the multi roller systems, this is the preferred one. Multi roller or two-way guide should be designed to continue the arc beyond the angle of deflection. In this way the minimum bending radii is always maintained.

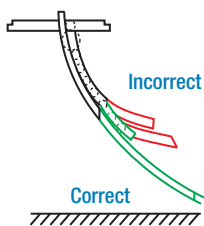

As a general note, you have to absolutely avoid any abrupt changes of the bending radius (often this is due to a not enough long angle of deflection of the roller guide arc). These changes lead to a punctual overpressure that results into a cable breakage.

#### Over and under tension protection

It is highly recommended that cable guiding systems include both under and over tension protection systems. Even a short exposure to over tension caused by mechanical failure or accidents can render a cable inoperable due to permanent conductor deformation or breakage. Conversely, under tension protection is desirable to ensure that cable cannot free spool from the reel and sustain damage. This protection is particularly important for high mounted cable reels. All over tension protection devices should be set to the maximum continuous safe working tension defined for each cable section.

#### Sheaves

Comparing them with the previously described guide types, some difficulties are clear. The sheaves' weight increases inertia, so more torque is needed to compensate it giving a final increase on cable tension so reducing its life. Another disadvantage to be considered from using a sheaved guide is the detrimental effect onto the cable outer sheath that is directly in contact with the sheave circumference. This contact area should increase if a hollow internal sheave shape is used. This becomes a particularly significant condition that will lead to a considerable reducing of the cable life and this is why we suggest to use a correct sheave profile as shown in the below image.

#### Incorrect sheaved profile

Torsion is induced on the cable due to rolling effect leading to a reducing in cable life.

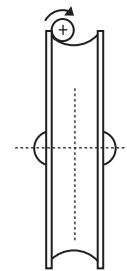

#### Correct sheaved profile

This design minimizes torsion applied on the cable.

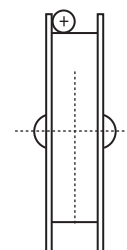

### Change of direction

At the designing stage of a cable winding system, please keep an eye on leaving enough distance between any changes of direction. The best and recommended distance should be at least 20 times the cable OD (even longer for high speed systems). This behavior will leave the cable to regain its starting shape before suffering another bending.

## Anchoring systems

Correct cable anchoring is important in establishing reliable operation of a cable handling system. According to the cable handling system typology, different methods may be used, but all of them share the same basic intent: spread the tensile forces over a sufficient large cable sheath area in order to avoid damage or failures at the anchoring point.

The most common mobile anchor points are performed using the ordinary terminals or “cable grips”.

In these cases it is recommended that the tensile load would be distributed over an end length of the cable equal to 20/25 times its OD, and that a slack loop of cable will be left before entry into the terminal box in order to allow the operating movements.

When an underground centre point attachment is installed, the vertical distance between the entry bell and the crane’s payout guide should not be less than 15 times the cable OD or 1m, whichever is larger. At least 2½ cable turns should be wound around the fixed stress relief drum to ensure sufficient contact area for an adequate stress relief.

Dynamic tensile stress on the cable can lead to premature failure, especially in high travel speed applications. In order to minimize this, several solutions are at hand, as the most important - according to our experience - is a travel speed reduction device. This system can be incorporated with most reel drive designs. It reduces the travel speed before reaching the centre point, and then re-accelerates once the centre point has been passed and the reel direction of rotation has been reversed.

### Anchoring system for center crossover

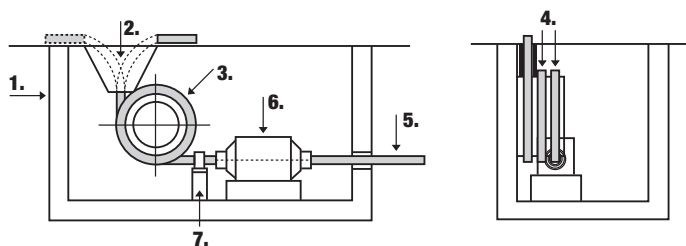

- 1. Cable support
- 2. Entry bell
- 3. Stress bearing drum
- 4. Cable wound twice (2½) around stress bearing drum

- 5. Supply cable
- 6. Cable termination box
- 7. Clamp

## Cable reels

Cable life and performances is tightly connected to the reeling design. A well designed reeling system, combined with the correct choice of the cables, secures optimal performances of the whole system and also can assure a long lasting operative cables, increasing their life and reliability.

Today’s market uses a wide range of cable reels that can be summarized in three main types: you can find herewith a brief description of each one with some hints about their advantages and disadvantages.

### Mono-Spiral reel

It is one of the most diffused. It has a simple guide route that gives - as a result - an extension to the cable’s own life in comparison to the other types.

Moreover on these cable reels (due to the improved heat dissipation), the conductor size for the power cables are generally smaller in comparison to the other kind of reels.

The cable diameter and length are main factors to be considered for the application on mono-spiral reels: the good balance between reel’s inner and outer diameter, will be critical for determining and controlling the cable tension.

### Random Wound reel

It is the simplest type amongst the existing cable reels: it operates without guides so the random layering can create severe operational difficulties such as slippage of coils, abrupt tensile forces, torsion, abrasions and abnormal build-ups.

For these main reasons this application can support only small cable diameters and short runs: 250m maximum run, and a weight approx. < 4 kg/m.

### Multi-spiral reel

It is indicated for large cable diameters and long lengths. The main advantage on using this type of reel is its ability to carry large amount of cable (even with large diameters) at a constant reeling tension and for long distances.

On the other hand, normally due to the reel location, is also difficult to reduce the number of guides and changes of direction on this type of installation.

## Handling and installation

For optimum long life service, laying operations must be carried out by expert personnel. In addition to the normal measures to be observed when laying cables, the following recommendations, specific to the operating conditions for mobile cables, must be strictly adhered to.

It's always a good practice to test the installation a few times as soon as the cable has been laid to check operation and immediately correct any eventual defects or faults.

### Handling of cable

Storing and handling of cables on the original drums is recommended in order to prevent the formation of defects caused by loose coils.

If possible avoid, or at least minimize, to roll the drums on its flanges: on the other hand, use a fork-lifter or crane to move the reel. If you cannot avoid to roll the drum, do it against the coiling direction not following. This small suggestion will keep the cable coiled tight to the reel and will prevent any torsion or abrupt tensions given by loose coil action.

A further recommendation regards storage.

Spare cables have to remain on their original drums (it prevents coils slumping); moreover - even you consider either a short or long cable storage - the cables' drums must be kept in a cool, dry and shaded location and the cable's ends must be sealed (as done on first delivery) in order to prevent the entrance of moisture and dirt.



### Fork lifting operating

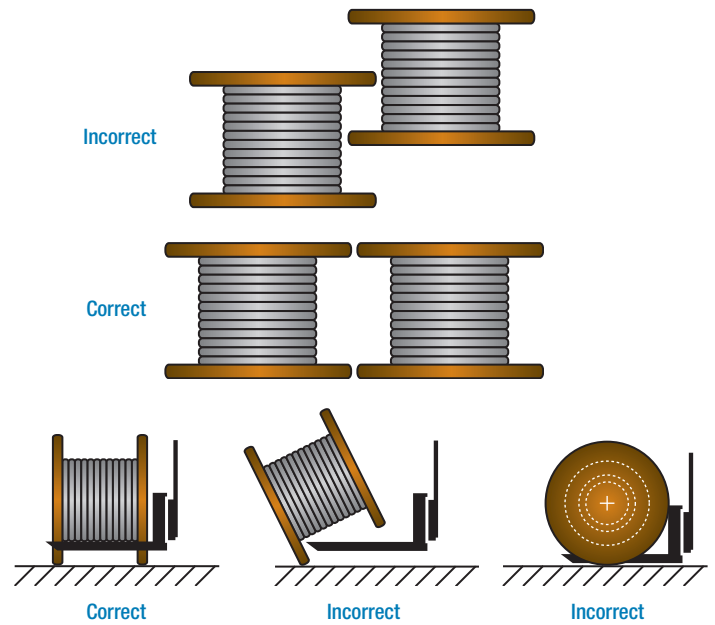

### Cable installation

Generally, when a cable is installed onto a force guidance system as the reeler, festoons, gravity-fed (spreader) basket, the transport drum should be jacked up above ground level.

The preferred method to operate a cable installation on site consist first of all in jacking up the original drum then unwinding the cable all along the entire machine's travel route. You can use conventional cable pulling equipment and rollers to perform this action.

Sometimes these procedures cannot be used due to the environment or site conditions so you can act transferring it directly from the drum to the reel. It is also a recommended method when reel location and/or cable runaway are not accessible.

In this case you must avoid to introduce "S" bending between the drum and the reel. Whenever possible the cable should be transferred directly without passing through or over any rollers or change of directions.

The directly transferring from the transport drum to the final reel must be done slowly and with a minimum tension: this behavior would avoid any torsional influence during cable installation.

The following pictures show how to proceed generally when unreeling the cable from the original drum and transferring it directly to the final operating system.

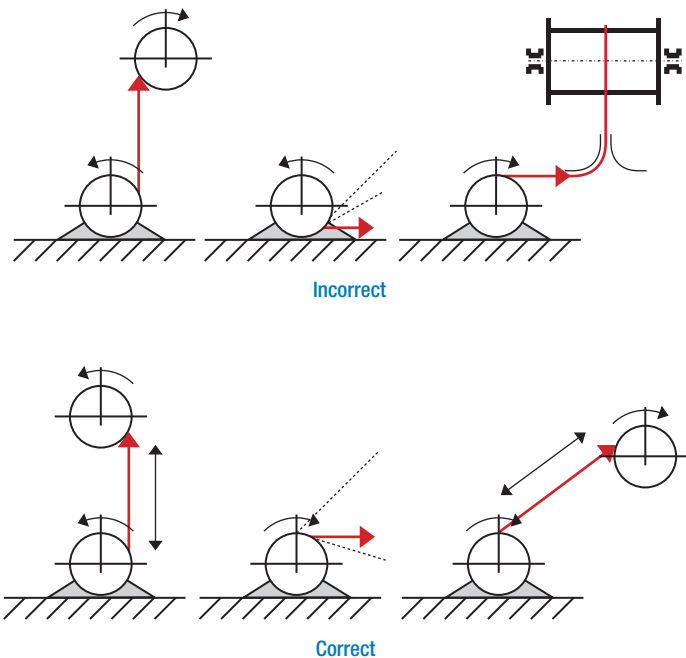

The spiral will be rolled to the free end of the cable in order to remove any twisting. This action must be performed again for each founded twisting. Then re-anchor the cable to start operation.

If during the first test-running of the equipment you still find a slight or residual twisting, lead the machine to the end run then un-anchor the cable (eventually cutting 25/50cm of cable) and eliminate the torsion. After this, re-anchor the cable and have a final check.

Please keep in mind that a cable correctly installed, if no torsions are introduced by guides or unnatural bending, it cannot twist (for an evident physical law).

For this reason we suggest that during the final check, you draw some marks on the cable than let the machine run in order to can easily determinate if the cable starts to twist.

If yes the whole system has to be stopped in order to find and eliminate the external cause of the torsion.

Note: the cable marking can show a natural slight spiral effect (more evident on long cable lengths), but this aspect is totally not related to any kind of twisting problem.

## Twist removal

If, during the above procedure, the cable has become twisted, we strongly recommend to eliminate it. Normally two methods are foreseen to perform this action.

### Wave Motion

Insert a cylinder roller (the diameter of which should be between 15/20 cm) underneath the cable near to the twisting. At this point two people should walk handling the roller and pushing the “wave” towards the end of the cable.

You can perform this action until the detected twist is removed.

### Spiral Method

This could be carried out by one person only and will reach the same effect described above. Allow enough cable from the fixed end of the cable (better from the drum jacked on) in order to obtain a spiral. This should be a right side or a left side one according to the direction of the detected twist.

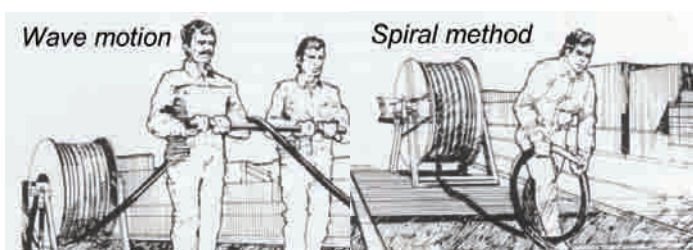

## Cable installation on multi-spire reels

PANZERFLEX crane cables are manufactured with right hand lay-up of the conductors (power and control cable) and therefore when winding onto multi-spiral reels, the first turn must be with the cable against the right flange of the reel.

This will have the effect of exploiting the natural tendency of the cable under traction to move to the right, keeping subsequent turns close together.

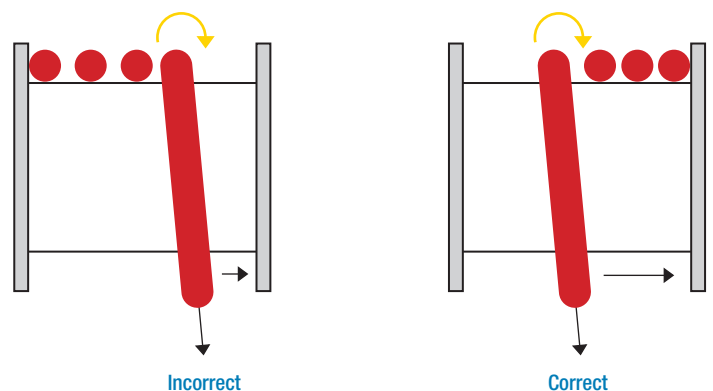

To assist the movement of the cable over guide rollers, sheaves, etc. a dry lubricant or a silicone based grease may be used as these types of lubricants avoid dust and dirt from adhering to the lubricated surface.

## Cables installation for vertical application (BASKETHEAVYFLEX, PANZERFLEX-VS, PANZERLITE)

### Anchoring systems

Cables installation on a spreader or other kind of vertical application, needs to follow some major attention, mainly due to the specific kind of application.

Main recommendations given in the previous paragraphs (wound the cable from the original drum; avoid to subject the cable to unnecessary loops, torsion or twisting; eliminate any eventual torsion, etc.) must be followed also for these cables.

Moreover the installation has to go after all the topics given herewith.

The best anchoring is achieved with a stress relief drum as shown on the below picture. The open ended construction facilitates installation and replacement while affording better stress relieve and sheath protection than cable grips. In this case at least 2½ cable turns should be wound around the drum. The table “Bending radii” show the minimum bending radii of stress relief.

If, on the other hand, the anchoring would be made with a grip, a recommended length of coverage over the cable is 20/25 times the cable OD. This will aid in spreading the dynamic stresses over a sufficient sheath surface area to inhibit cable damage.

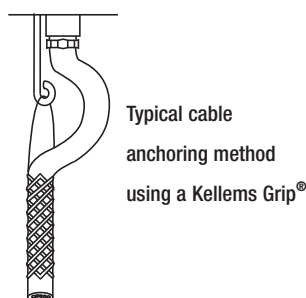
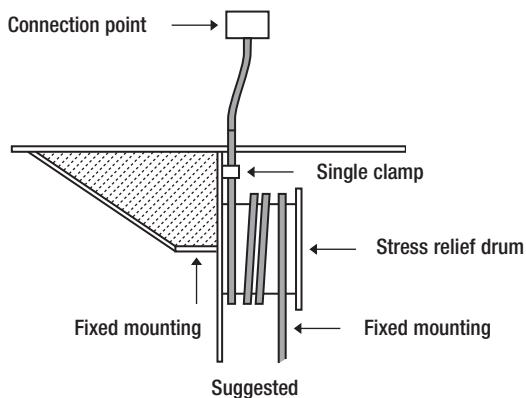

### PANZERFLEX-VS, PANZERLITE

#### Fix the bottom

When necessary, the bottom of these cables would be fixed by a suitable grip. The sheath coverage is the same of the anchoring system (20/25 OD of the cable). The distance from the end of anchoring device to the end of the machine travel should be at least 40 x cable OD. If frequent dynamic stresses near the anchor point are anticipated a spring may be used.

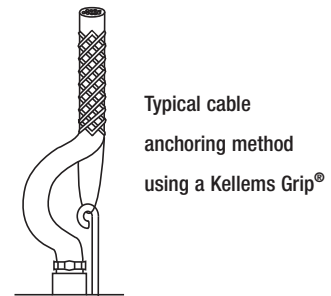

### BASKETHEAVYFLEX

#### Suggested cable coiling

Even if the Basketheavyflex cable has been especially designed for this type of application, the correct design of the basket is important not only as far as cable life is concerned, but also to avoid operating malfunction. High stress applications will be typically involve long vertical lengths, high speed combined ascent and descent with movement and, often, the presence of strong winds.

In these cases care must be taken to ensure that coiling diameter is not less than 1.5 m. A centrally guide cone centrally placed into the basket is recommended for even coiling the cable correctly.

The shape of the basket and of the opening are also important operating factors: with high lift and high speed a height of at least 2 m and a conical opening are recommended.

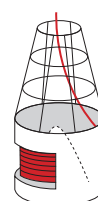

Good cable coiling

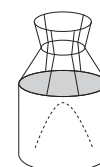

Less controlled coiling

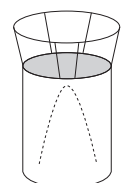

Poor coiling control



The cable has to be laid, from the bottom of the basket, in anticlockwise direction starting from the outer layer of the original cable drum.

Scope of the information given herewith is to assure the PALAZZO PRYSMIAN's deep commitment to giving the customer the best support for a perfect use of our products.

Life and performance of our PANZERFLEX, depend directly on all the recommendations and figures stated in this technical section. Furthermore we would like to underline that the main topics that must be regularly and carefully checked are:

- the perfect alignment of all equipments such as: lyres, reels, sheaves, etc.
- all the protection devices in order to avoid over and under tensions.
- any twisting induced (and not released) during installation or test-run activities.

The misuse of even one the above instructions will surely lead to premature cable failures.

## ELECTRICAL

### Electrical parameters

#### Voltages

For the rated, operating and test voltages of cables, the definitions given in DIN VDE 0298, Part3, apply. Some of these are mentioned in table 2.

**AC** - alternating current

**DC** - direct current

#### Rated voltage

The rated voltage of an insulated electric cable is the voltage which is used as the basis for the design and the testing of the cable with regard to its electrical characteristics.

The rated voltage is expressed by the two values of power frequency voltage  $U_0/U$  in V.

- $U_0$  rms value between one conductor and "earth"
- $U$  rms value between two conductors of a multi-core cable or of a system of single-core cables

In a system with AC voltage, the rated voltage of a cable must be at least equal to the rated voltage of the system for which it is used. This requirement applies both to the value  $U_0$  and the value  $U$ .

In a system with DC voltage, its rated voltage must not be more than 1.5 times the value of the rated voltage of the cable.

#### Operating voltage

The operating voltage is the voltage applied between the conductors

and earth of a power installation with respect to time and place with trouble-free operation.

#### • Cables with a rated voltage $U_0/U$ up to 0.6/1 kV

These cables are suitable for use in three-phase AC, single-phase AC and DC installations, the maximum continuously permissible operating voltage of which does not exceed the rated voltage of the cables by more than 10% for cables with a rated voltage  $U_0/U$  up to and including 450/750 V 20% for cables with a rated voltage  $U_0/U = 0.6/1$  kV.

#### • Cables with a rated voltage $U_0/U$ greater than 0.6/1 kV

These cables are suitable for use in three-phase and single-phase AC installations, the maximum operating voltage of which does not exceed the rated voltage of the cable by more than 20%.

#### • Cables in DC installations

If the cables are used in DC installations, the continuously permissible DC operating voltage between the conductors must not exceed 1.5 times the value of the permissible AC operating voltage. In single-phase earthed DC installations, this value should be multiplied by a factor of 0.5.

#### Test voltage

Regarding the test voltage of flexible cables, the values given in the corresponding parts of DIN VDE 0250 apply.

Table 2

FLEXIBLE CABLE	RATED VOLTAGE U <sub>0</sub> /U	MAX PERMISSIBLE OPERATING VOLTAGE			TEST VOLTAGE APPLIED TO THE COMPLETE CABLE		
		IN AC SYSTEM U <sub>0</sub> /U	IN DC SYSTEM U kV	SINGLE-PHASE EARTHED U kV	POWER CORES kV	CONTROL CORES kV	PILOT CORES kV
BasketHeavyFlex	300/500 V	318/550 V	0.825	0.413	2	-	-
Flexiflat	450/750 V	476/825 V	1.238	0.619	2.5	-	-
Panzerflex-L / Panzerflex-VS / Panzerlite	0.6/1 kV	0.7/1.2 kV	1.8	0.9	3.5	2	-
	3.6/6 kV	4.2/7.2 kV	10.8	5.4	11	2	2
	6/10 kV	6.9/12 kV	18	8	17	2	2
Panzerflex-EL / Panzerflat	8.7/15 kV	10.4/18 kV	27	14	24	2	2
	12/20 kV	13.9/24 kV	36	18	29	2	2
	18/30 kV	20.8/36 kV	54	27	43	2	2

### Calculation of cable cross section

For the transmission of a given current under given operating conditions, the current carrying capacities for standard conditions of continuous operation discussed herewith must be adopted and necessary corrected.

Downwards adjustment may be required using correction factors for conditions relating to:

- ambient temperature
- number of layers and turns on reels
- number of conductors simultaneously under tension

It should not be forgotten that non continuous operation will mean better cable performance.

With the actual tendency to increase cable operating lengths it is wise to check voltage drop, not just for Low Voltages but for Medium to High Voltages too.

In some circumstances it may be necessary to check the resistance of the cable to short circuit currents both from a thermal view point and electro-dynamically induced forces.

### Current carrying capacity for continuous operation

The values for current carrying capacity and various correction factors given in the below table are the same as those defined by standard VDE 0298 Part 4, 08-2003.

Although the cables contained in this catalogue are insulated with ethylene propylene rubber (EPR) for which the admissible operating temperature for continuous operation is 90 °C, the current carrying capacities given here are for conductor temperature of 80 °C.

This is to conform to VDE standards and also as a precautionary measure to take into account greater difficulties with heat dispersion for this type of cable.

The values are for three core cable, with or without earth conductor, not wound and resting on the ground with ambient air temperature of 30°C. For installations where it is known that the life of the cable will be reduced as a result of high mechanical stress or wear in the sheathing, then thermal ageing will be of less importance. In this cases a maximum operating temperature of 90 °C can be considered and the capacities given in table from 3 to 6 can be increased by, approximately, 7%.



Courtesy of: REGGIANE CRANES and PLANTS - FANTUZZI GROUP - Italy



Courtesy of: REGGIANE CRANES and PLANTS - FANTUZZI GROUP - Italy



Table 3

Cables up to 10 kV										
CURRENT CARRYING CAPACITY										
CROSS-SECTION	STRETCHED LAYING	SUSPENDED FREELY IN AIR	1 LAYER	2 LAYERS	3 LAYERS*	4 LAYERS	REELED IN	5 LAYERS	6 LAYERS	7 LAYERS
mm <sup>2</sup>	A Factor 1	A 1.05	A 0,8	A 0,61	A 0,49	A 0,42	A 0,34	A 0,27	A 0,22	
1	18	19	14	11	9	8	6	5	4	
1,5	23	24	18	14	11	10	8	6	5	
2,5	30	32	24	18	15	13	10	8	7	
4	41	43	33	25	20	17	14	11	9	
6	53	56	42	32	26	22	18	14	12	
10	74	78	59	45	36	31	25	20	16	
16	99	104	79	60	49	42	34	27	22	
25	131	138	105	80	64	55	45	35	29	
35	162	170	130	99	79	68	55	44	36	
50	202	212	162	123	99	85	69	55	44	
70	250	263	200	153	123	105	85	68	55	
95	301	316	241	184	147	126	102	81	66	
120	352	370	282	215	172	148	120	95	77	
150	404	424	323	246	198	170	137	109	89	
185	461	484	369	281	226	194	157	124	101	
240	540	567	432	329	275	227	184	146	119	
300	620	651	496	378	304	260	211	167	136	

Cables above 10 kV										
16	105		84	64	51	44	36	28	23	
25	139		111	85	68	58	47	38	31	
35	172		138	105	84	72	58	46	38	
50	215		172	131	105	90	73	58	47	
70	265		212	162	130	111	90	72	58	
95	319		255	195	156	134	108	86	70	
120	371		297	226	182	156	126	100	82	
150	428		342	261	210	180	146	116	94	
185	488		390	298	239	205	166	132	107	
240	574		459	350	281	241	195	155	126	
300	660		528	403	323	277	224	178	145	

\* The reduction factor is also valid for flat reeling cables (spirally)

## De rating factors

The de-rating factors take into account the installation and operating conditions, such as temperature, grouping, intermittent periodic duty and the number of simultaneously loaded cores.

They are to be used for determining the current-carrying capacity in accordance with table 3.



Table 4

DE-RATING FACTORS FOR VARYING AMBIENT TEMPERATURES													
AMBIENT TEMPERATURE °C													
10	15	20	25	30	35	40	45	50	55	60	65	70	
1.18	1.14	1.10	1.05	1.00	0.95	0.89	0.84	0.77	0.71	0.63	0.55	0.45	

Table 5

DE-RATING FACTORS FOR GROUPING																	
ARRANGEMENT	Number of multi-core cables or number of single or three-phase circuits made up of single-core cables (2 or 3 loaded conductors)																
	1	2	3	4	5	6	7	8	9	10	12	14	16	18	20		
Bunched directly at the wall, the floor, in conduit or ducting, on or in the wall 	1,0	0,8	0,7	0,65	0,6	0,57	0,54	0,52	0,5	0,48	0,45	0,43	0,41	0,39	0,38		
Single layer on the wall or floor, touching 	1,0	0,85	0,79	0,75	0,73	0,72	0,72	0,72	0,71	0,70							
Single layer on the wall or floor, spaced with a clearance of 1 x cable diameter between adjacent cables 	1,0	0,94	0,9	0,9	0,9	0,9	0,9	0,9	0,9	0,9	0,9	0,9	0,9	0,9	0,9		
Single layer under ceiling, touching 	0,95	0,81	0,72	0,68	0,66	0,64	0,63	0,62	0,61								
Single layer under ceiling, spaced with a clearance of 1 x cable diameter between adjacent cables 	0,95	0,85	0,85	0,85	0,85	0,85	0,85	0,85	0,85	0,85	0,45	0,85	0,85	0,85	0,85		

Table 6

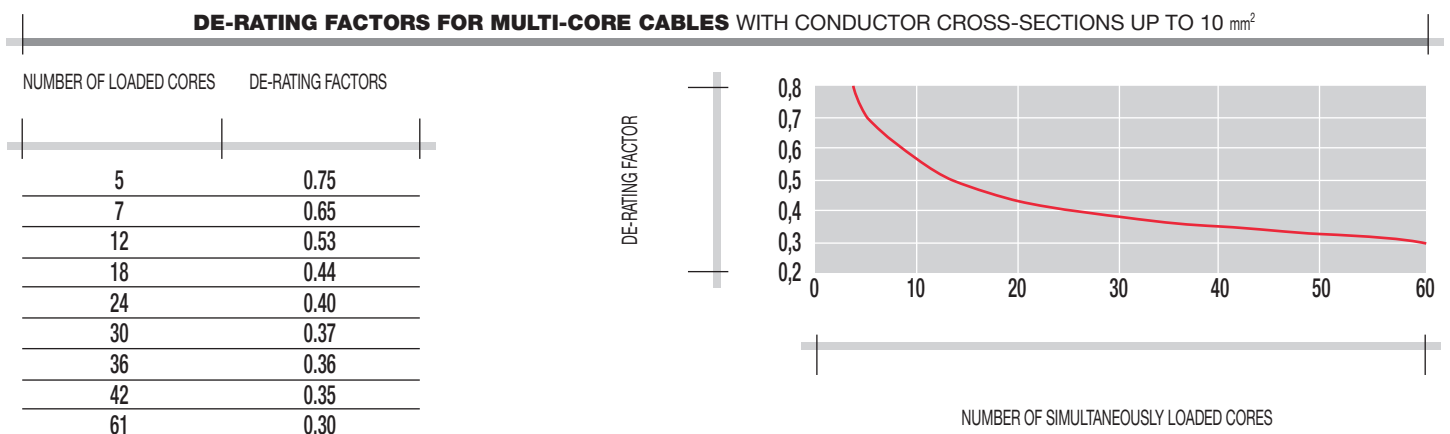

## Current carrying capacities for NON continuous operation

In some cases electrical operation is not continuous or it is only partially continuous. It may therefore be advisable to check the values for current circulating and operating times, to see whether the cross section of the cable can be reduced.

These 10 minutes taken as a percentage of total duration DT of the cycle provides provides a percentage load factor.

$$\text{Load Factor FC \%} = (10 \text{ mi} / \text{DT}) \times 100$$

A typical example of intermittent operation with hoisting equipment consists of repeated cycles where, for example, an operating period of 10 minutes of full load is followed by a longer period with no load.

In this case the current carrying capacity as calculated using table 3, can be increased using factors given in table 7.

Table 7

CORRECTION FACTORS FOR INTERMITTENT OPERATION																
CABLE CROSS SECTION (mm <sup>2</sup> )	1.5	2.5	4	6	10	16	25	35	50	70	95	120	150	185	240	300
LOAD FACTOR (FC %)	CORRECTION FACTORS															
60 %	1.00	1.00	1.00	1.00	1.03	1.07	1.10	1.13	1.16	1.18	1.20	1.21	1.22	1.23	1.24	1.25
40 %	1.00	1.00	1.03	1.04	1.09	1.16	1.23	1.28	1.34	1.38	1.42	1.44	1.46	1.48	1.49	1.50
25 %	1.00	1.02	1.05	1.13	1.21	1.34	1.45	1.53	1.62	1.69	1.74	1.78	1.81	1.82	1.85	1.87
20 %	1.00	1.04	1.11	1.18	1.31	1.45	1.59	1.69	1.79	1.87	1.93	1.97	2.01	2.04	2.10	2.15
15 %	1.00	1.08	1.19	1.27	1.44	1.62	1.79	1.90	2.03	2.13	2.21	2.26	2.30	2.32	2.36	2.39



## Short circuit current

### THERMAL limit of short circuit

In accordance with VDE standards 0250 c.8/75 the admissible THERMAL limits for short circuit current in heavy duty mobile service cables, must be calculated using the following reference values:

Initial = 80 °C (cable under full load)

Final short circuit temperature = 200 °C

The short circuit currents (thermal limit) given in the below table 8 have been calculated using these reference values and are valid for a base time of 1 sec.

For other time periods, taking into account the protection characteristics of the apparatus, the value in the table must be divided by the square root of the effective time (in seconds).

For different initial and final temperatures (i.e. with 90 °C and 250 °C admissible according to standards for EPR), the short circuit current (thermal limit) can be calculated using the following formula:

$$I_{cc} (A) = k_{cc} \times \text{cond. cross section (mm}^2) \times \sqrt{t} (\text{sec})$$

where the coefficient  $k_{cc}$  assumes the values in table 9.

Table 8

SHORT CIRCUIT CURRENT	
NOMINAL CABLE CROSS SECTION (mm <sup>2</sup> )	ONE SECOND THERMAL LIMIT FOR ALL VOLTAGES (kA)
1.5	0.20
2.5	0.32
4	0.51
6	0.77
10	1.29
16	2.06
25	3.22
35	4.50
50	6.43
70	9.00
95	12.2
120	15.4
150	19.3
185	23.8
240	31.0

Table 9

FINAL SHORT CIRCUIT TEMPERATURE IN C	INITIAL SHORT CIRCUIT TEMPERATURE OF THE CONDUCTOR UNDER NORMAL OPERATING CONDITIONS						
	30 °C	40 °C	50 °C	60 °C	70 °C	80 °C	90 °C
160	143	136	129	122	115	107	100
200	159	153	147	141	135	128	122
250	176	170	159	159	154	148	143



Courtesy of: REGGIANE CRANES and PLANTS - FANTUZZI GROUP - Italy

Table 10

VOLTAGE DROP CALCULATION						
NOMINAL CROSS SECTION	A.C. RESISTANCE AT 50 Hz and 80 °C (R) Ohm/km	REACTANCE AT 50 Hz FOR THREE CORE CABLE (3 PHASE + EARTH) AT OPERATING VOLTAGE:				
		≤ 0,6/1 kV (X) Ohm/km	3,6/6 kV (X) Ohm/km	6/10 (X) Ohm/km	8,7/15 (X) Ohm/km	12/20 (X) Ohm/km
1,5	16,9	0,103				
2,5	10,1	0,095				
4	6,29	0,092				
6	4,19	0,086				
10	2,41	0,083				
16	1,53	0,078				
25	0,983	0,078	0,108	0,111	0,118	0,126
35	0,699	0,075	0,102	0,105	0,111	0,118
50	0,486	0,075	0,097	0,100	0,105	0,112
70	0,343	0,073	0,092	0,095	0,100	0,106
95	0,261	0,072	0,088	0,091	0,095	0,101
120	0,204	0,071	0,085	0,087	0,092	0,097
150	0,165	0,071	0,083	0,085	0,089	0,094
185	0,136	0,071	0,081	0,083	0,087	0,091
240	0,104	0,070	0,080	0,082	0,084	

## Calculation of voltage drop

### Three phase voltage drop

Voltage drop should be checked not just for Low Voltage but also for Medium Voltage connections where lengths are long.

The value is calculated by multiplying the factors K (mV/Am) of the cable then by the length of the connection L (in km).

The formula to calculate the voltage drop is the following:

$$\Delta V = I \times L \times K \text{ (Volt)}$$

where  $K = 1,73 \times (R \cos\varphi + X \sin\varphi)$

I = (A) effective current capacity

L = (km) length of the connection

R = (Ohm/km) a.c. conductor resistance at 80 °C (see table 10 above)

X = (Ohm/km) cable reactance at 50 Hz (see table 10 above)

Values for electrical resistance R (80°C) and for reactance X (calculated for round cables, 3 cores + 3 earth, but valid also for flat cables with sufficient approximation) are also given in the above table 10.

It should be noted that for conductor temperatures of 90 °C the resistance R must be multiplied by 1.03 while for a frequency of

60Hz the reactance X must be multiplied by 1.2 and the value for K (mV/Am) recalculated.



Courtesy of: REGGIANE CRANES and PLANTS - FANTUZZI GROUP - Italy

## DRUM DIMENSIONS AND WEIGHT

TYPE (n)	D1	D2	L2	L1	NET WEIGHT	BULK SPACE	VOLUME (STAVED)
	(mm)	(mm)	(mm)	(mm)	(kg)	(mm <sup>3</sup> )	(mm <sup>3</sup> )
06	630	315	335	410	16	0.34	0.23
07	710	355	420	495	20	0.45	0.33
08	800	400	470	545	28	0.54	0.46
09	900	450	470	565	36	0.63	0.59
10	1000	500	580	675	55	0.81	0.84
12	1250	630	630	740	85	1.09	1.42
14	1400	710	750	870	125	1.41	2.04
16	1600	900	900	1055	190	1.92	3.18
18	1800	1120	1140	1315	270	2.63	4.90
20	2000	1250	1140	1325	365	2.94	6.05
22R	2240	1300	1000	1185	450	2.96	6.80
22	2240	1400	1140	1325	480	3.28	7.54
25	2450	1500	1140	1325	600	3.58	8.98
26S	2600	1600	1140	1365	770	3.90	10.37
25S pal	2450	1250	1270	1455	650	3.90	9.80
26S pal	2600	1250	1270	1455	800	3.56	11.00

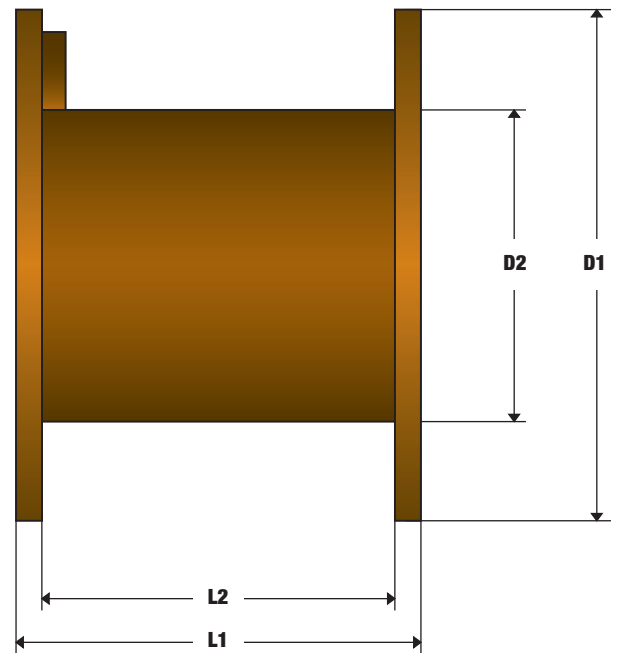

On the above table you can find our most common types of drum. For each one also we provide internal and external dimensions, weight, bulk space and volume. Please consider that a staved drum increase its dimension D1 of 5mm in total.









Prysmian reserves the right to modify at any time the technical, dimensional and weight characteristics shown in this catalogue anyhow always in accordance to the mentioned Standards in case it improves the features of its products.

There is no responsibility of the manufacturer for damages to persons and property in case of improper use and/or neglecting the recommendations for using cables and norms, contained in this catalogue, relevant to installation and operation.

**Warranty:** all cables described in this catalogue are warranted in accordance with the standards terms and sales conditions of PALAZZO PRYSMIAN. The warranty will cover the 18 months from the cable buy or the 12 months for the installation on site. This period warranty is strictly based on the correct use of the product as described in this catalogue. We insist on the importance of the correct cable selection for the specific installation in order to ensure either that the warranty will be applicable, either to provide a long and trouble free performance.